

2013 Buick Regal Infotainment System

Infotainment System	3	Navigation	47	Bluetooth Phone/ Devices	79
Introduction	3	Using the Navigation System	47	Bluetooth	79
Infotainment	3	Maps	51	Hands-Free Phone	86
Overview	3	Navigation Symbols	51	Trademarks and License Agreements	87
Steering Wheel Controls	8	Destination	54	Index	i-1
Using the System	9	OnStar® Destination Download	63		
Radio	14	Configure Menu	64		
AM-FM Radio	14	Global Positioning System (GPS)	70		
Radio Data System (RDS)	17	Vehicle Positioning	70		
Satellite Radio	17	Problems with Route Guidance	71		
Radio Reception	24	If the System Needs Service	72		
Backglass Antenna	25	Map Data Updates	72		
Quick Info	26	Database Coverage Explanations	72		
Pandora Internet Radio	26	Voice Recognition	72		
Stitcher Internet Radio	32				
Pictures	36				
Audio Players	37				
CD Player	37				
USB	39				
Auxiliary Devices	45				
Bluetooth Audio	46				

Introduction

Infotainment



The names, logos, emblems, slogans, vehicle model names, and vehicle body designs appearing in this manual including, but not limited to, GM, the GM logo, BUICK, the BUICK Emblem, and the name Regal, are registered trademarks of General Motors Corporation LLC, its subsidiaries, affiliates, or licensors.

This manual describes features that may or may not be on your specific vehicle either because they are options that you did not purchase or due to changes subsequent to the printing of this owner manual. Please refer to the purchase documentation relating to your specific vehicle to confirm each of the features found on your vehicle. For vehicles first sold in Canada, substitute the name General Motors of Canada Limited for Buick Motor Division, whenever it appears in this manual.

Keep this manual with the owner manual in the vehicle, so it will be there if it is needed. If the vehicle is sold, leave this manual in the vehicle.

Overview

Read the following pages to become familiar with the infotainment system features.

WARNING

Taking your eyes off the road for extended periods could cause a crash resulting in injury or death to you or others. Do not give extended attention to infotainment tasks while driving.

The infotainment system has built-in features intended to help with this by disabling some functions when driving. A grayed-out function is not available when the vehicle is moving.

4 Infotainment System

All functions are available when the vehicle is parked. Before driving:

- Become familiar with the infotainment system operation, buttons on the faceplate, and touch-sensitive screen buttons.
- Set up the audio by presetting favorite stations, setting the tone, and adjusting the speakers.
- Set up phone numbers in advance so they can be called easily by pressing a single button or a single voice command for vehicles equipped with phone capability.

WARNING

Taking your eyes off the road too long or too often while using the infotainment system could cause a crash and you or others could be injured or killed. Focus your attention on driving and limit glances at the moving map on the navigation screen. Use voice recognition whenever possible.

See “Defensive Driving” in the Index of the vehicle owner manual for more information.

The vehicle has Retained Accessory Power (RAP). With RAP, the audio system can be played even after the ignition is turned off. See “Retained Accessory Power (RAP)” in the owner manual.

Customer Assistance

Assistance is available to help with Bluetooth pairing, application downloading and installation, other mobile device interface, and operation support of the infotainment system. Specialists are available when calling this Customer Assistance number, U.S. (855) 4 SUPPORT (478-7767).

Infotainment System Overview

The infotainment system is controlled by using the buttons, touch screen, steering wheel controls, and voice recognition.

See *Using the System on page 9*.

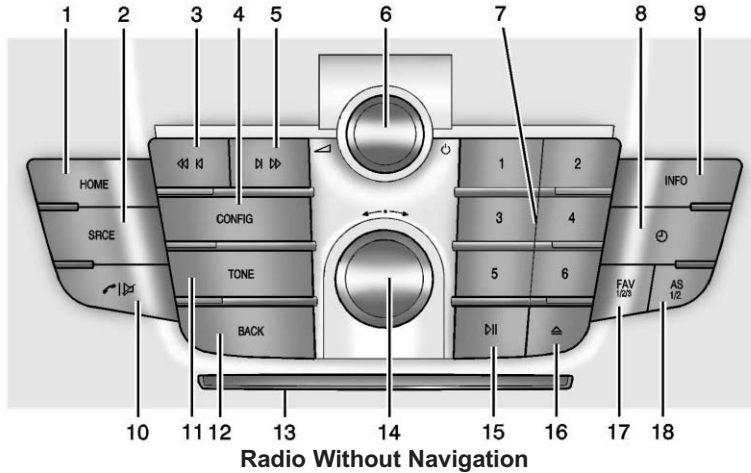

1. HOME
2. SRCE (Source)
3. ◀◀ (Previous/Reverse)
4. CONFIG (Configuration Menu)
5. ▶▶ (Next/Fast Forward)
6. 🔊 / ⏻ (Volume/Power)
7. Buttons 1-6
8. ⌚ (Clock Menu)
9. INFO (Information)
10. 📞 / 🚫 (Phone/Mute)
11. TONE
12. BACK
13. CD Slot
14. Menu Knob
15. ▶ || (Play/Pause)
16. ⏏ (Eject)
17. FAV 1/2/3 (Favorite Pages)
18. AS 1/2 (Autostore)

6 Infotainment System

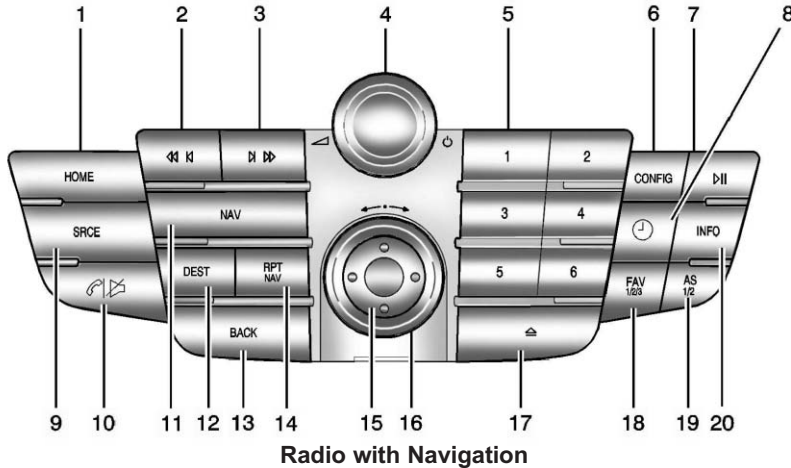

Radio with Navigation

1. HOME
2. ◀◀ / ◀ (Previous/Reverse)
3. ▶ / ▶▶ (Next/Fast Forward)
4. ▲ / ⏻ (Volume/Power)
5. Preset Buttons 1–6
6. CONFIG (Configuration)
7. ▶/|| (Play/Pause)
8. ⌚ (Clock)
9. SRCE (Source)
10. 📞 / 🚫 (Phone/Mute)
11. NAV (Navigation)
12. DEST (Destination)
13. BACK
14. RPT/NAV (Repeat Navigation)
15. Inner Rocker Knob
16. Menu Knob
17. ⏏ (Eject)
18. FAV 1/2/3 (Favorite)

19. AS 1/2 (Automatic Store)

20. INFO (Information)

Infotainment Control Buttons

The buttons on the faceplate are used to start primary functions while using the infotainment system.

HOME: See “Home Page” following in this section.

(Previous/Reverse):

1. Press to go back to the beginning of the current or previous track. If the track has been playing for less than five seconds, it seeks the previous track. If longer than five seconds, the current track starts from the beginning.
2. Press and hold to quickly reverse through a track. Release the button to return to playing speed. See *CD Player on page 37*.
3. For AM, FM, or XM (if equipped), press to seek to the previous strong station.

(Next/Fast Forward):

1. Press to move forward to the next track.
2. Press and hold to fast forward through a track.
3. Release the button to return to playing speed. See *CD Player on page 37*.
4. For AM, FM, or XM (if equipped), press to seek to the next strong station.

(Volume/Power):

1. Press to turn the system on and off.
2. Turn to adjust the volume.

Preset Buttons (1–6): The preset buttons numbered one through six can be used to select stored AM, FM, and XM (if equipped) stations.

CONFIG (Configuration Menu): Press to adjust features for radio, navigation, display, phone, vehicle, and time. See *Configure Menu on page 64*.

 (Play/Pause): Press to pause or resume play. See *CD Player on page 37*.

 (Clock): Press to set the time.

SRCE (Source): Press to change the audio sources such as AM-FM Radio, XM™ (if equipped), CD, and AUX.

 (Phone/Mute): See *Bluetooth on page 79* and *Hands-Free Phone on page 86*.

NAV (Navigation):

1. Press to view the vehicle's current position on the map screen.
2. Continue pressing to cycle through the full map and split screens.

DEST (Destination):

1. Press to enter a destination.
2. If a destination has already been entered, press to access the Destination Menu. See *Destination on page 54*.

8 Infotainment System

BACK: Press to return to the previous screen in a menu.

If on a page accessed directly by a faceplate button or Home Page screen button, pressing BACK will go to the Home Page.

RPT/NAV (Repeat Navigation): Press to repeat the last voice guidance prompt.

Inner Rocker Knob (Navigation): Move the rocker knob in different directions to navigate through the map display only.

Menu Knob: Turn to highlight a feature. Press the outer chrome ring to activate the highlighted feature.

△ (Eject): Press to eject a disc from the CD player. See *CD Player* on page 37.

FAV 1/2/3 (Favorite Pages): Press to display the current page number above the preset buttons. The stored stations for each list display on the touch-sensitive preset

buttons at the bottom of the screen. The number of preset FAV lists can be changed in the Configure Menu.

AS 1/2 (Automatic Store): Autostore searches and stores FM and AM stations with the strongest signal. Autostore does not function with XM radio stations.

INFO (Information): Press to toggle through an audio or navigation information screen.

Autostore

To use Autostore:

1. Press SRCE to select FM or AM.
2. Press the AS 1/2 button for two seconds.
3. The radio searches and automatically stores the six strongest stations.

Press the AS 1/2 button to alternate between the Autostore stations and favorites.

Autostore does not delete previously stored favorite stations.

Autostore does not function with SiriusXM radio stations.

Touch Screen Buttons

Touch screen buttons are on the screen and highlighted when a feature is available. Some toggle screen buttons highlight when active and gray out when inactive.

Steering Wheel Controls

Depending on the vehicle options, some audio functions can be controlled through the steering wheel controls.

☎ / 🗨️ (Push to Talk): Press to interact with Bluetooth or voice recognition. See *Bluetooth* on page 79 or *Voice Recognition* on page 72.

📞 / 🚫 (Mute/End Call): Press to decline an incoming call, or to end a current call. Press to silence the vehicle speakers while using the infotainment system. Press again to turn the sound on. Press to cancel voice recognition.

△ SRC ▽ (Thumbwheel Control): Press to select an audio source.

Use the thumbwheel to select the next or previous favorite radio station, CD, MP3 track, USB, and Bluetooth Audio.

Use △ SRC to skip to the next song or show using Pandora or Stitcher. See *Pandora Internet Radio on page 26* and *Stitcher Internet Radio on page 32*.



+ ▢ - (Volume): Press + to increase the volume. Press - to decrease.

See “Steering Wheel Controls” in the owner manual.

Using the System

The infotainment system is controlled by touching the screen, and by using the knobs and other buttons.

Voice recognition, through the steering wheel controls, can be used to control the infotainment features.

Press  /  on the steering wheel controls to begin voice recognition. See *Voice Recognition on page 72*.

Home Page

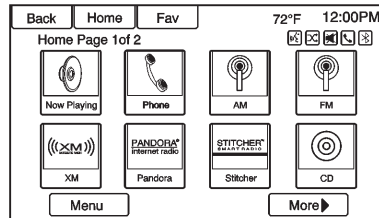

Touch Screen Buttons

The Home Page allows access to many of the features.

Back: Press to return to the previous page.

Home: Press to go back to the Home Page.

Fav: Press to display a page of stored favorites AM, FM, or SiriusXM® (if equipped) stations. Keep pressing Fav to scroll through the favorite pages.

More ▶ : Press to go to the next page.

Home Page Customization

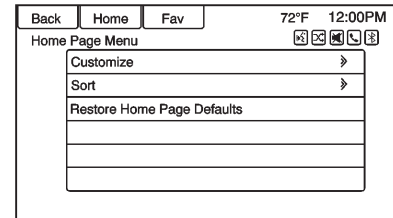

The first Home Page can be customized.

To add screen buttons:

1. Press Menu.
2. Press Customize.

10 Infotainment System

3. Press a screen button to add or remove from the first Home Page. A ● indicates it will be displayed. The maximum number of buttons on Home Page 1 is eight.

4. Press Done.

To move screen buttons:

1. Press Sort.

2. Press an icon to switch with another icon on the first Home Page only.

3. Press Done.

To restore Home Page 1 defaults:

1. Press Menu.

2. Press Restore Home Page Defaults.

3. Press Yes or Cancel.

Home Page Features

Touch screen buttons are highlighted when a feature is available.

Various functions are disabled when the vehicle is moving.



Press the Now Playing screen button to display the active source page. The sources available are AM, FM, XM (if equipped), CD, USB/iPod, Pandora (if equipped), Stitcher, and AUX.

See *AM-FM Radio on page 14*, *Satellite Radio on page 17*, *CD Player on page 37*, *Pandora Internet Radio on page 26*, *Stitcher Internet Radio on page 32*, and *Auxiliary Devices on page 45*.



Press the Navigation screen button to display a map of your current vehicle position. See *Using the Navigation System on page 47*, *Maps on page 51*, *Navigation Symbols on page 51*, and *Configure Menu on page 64*.



Press the Destination screen button to display the Destination Entry home page or the Destination Menu. The available screen buttons provide easy access to a variety of ways to enter a destination. See *Destination on page 54*.



Press the Phone screen button to display the Phone main page. See *Bluetooth on page 79* and *Hands-Free Phone on page 86*.

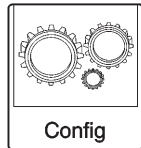

Press the Config screen button to display the Config main page. From this display, adjust features such as time and date, radio, phone, navigation, vehicle, and display. See *Configure Menu on page 64*.

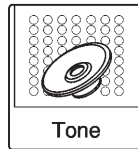

Press the Tone screen button to display the Tone main page. Adjust the tone and speakers by pressing the screen buttons to change the levels of sound for treble, midrange, bass, fade, and balance. See *AM-FM Radio on page 14*.

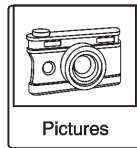

Press the Pictures screen button to view pictures on your USB drive or SD card. Pictures on the SD card can only be viewed through a USB adapter. See *Pictures on page 36*.

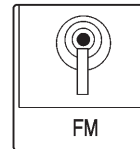

Press the FM screen button to display the FM main page and play the current or last tuned FM station. See *AM-FM Radio on page 14*.

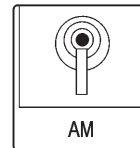

Press the AM screen button to display the AM main page and play the current or last tuned AM station. See *AM-FM Radio on page 14*.

12 Infotainment System

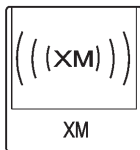

Press the XM screen button (if equipped) to display the XM main page and play the current or last tuned SiriusXM channel. See *AM-FM Radio on page 14* and *Satellite Radio on page 17*.



Press the Pandora screen button (if equipped) to display the Pandora home page and streams personalized radio stations based on artists, songs, genres, and comedians. See *Pandora Internet Radio on page 26*.



Press the Stitcher screen button (if equipped) to display the Stitcher home page and streams news, sports, and entertainment shows through the audio system. See *Stitcher Internet Radio on page 32*.

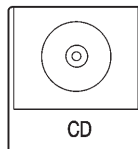

Press the CD screen button to display the CD main page and play the current or last CD track selected. See *CD Player on page 37*.

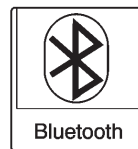

Press the Bluetooth screen button to display the Bluetooth Audio main page to play music through a Bluetooth device. See *Bluetooth Audio on page 46*.

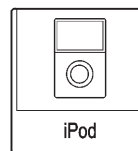

Press the iPod screen button to display the iPod main page and play the current or last track selected. See *Auxiliary Devices on page 45*.

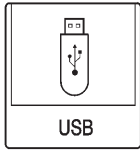

Press the USB screen button to display the USB main page and play the current or last track selected. See *Auxiliary Devices on page 45*.

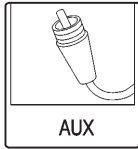

Press the AUX screen button to access any connected auxiliary device. See *Auxiliary Devices on page 45*.

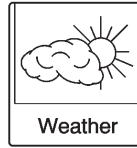

Press the Weather screen button (if equipped) to display the weather main page. Select other weather-related options from that list. See "Weather (If Equipped)" under *Satellite Radio on page 17*.

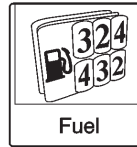

Press the Fuel screen button (if equipped) to display detailed nationwide fuel price. See "Fuel Pricing" under *Satellite Radio on page 17*.

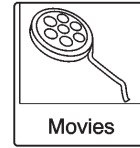

Press the Movies screen button (if equipped) to show detailed of local movie theater listings, start times, and ratings if available. See "Movie Listings" in *Satellite Radio on page 17*.

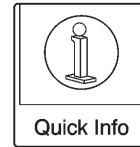

Press the Quick Info screen button to access information on Audio playing, OnStar Turn-by-Turn route (if equipped), 5-day forecast, Nearby Fuel Stations, and Movie Showtimes. See *Quick Info on page 26*.

Cleaning High Gloss Surfaces and Vehicle Information and Radio Displays

For vehicles with high gloss surfaces or vehicle displays, use a microfiber cloth to wipe surfaces. Before wiping the surface with the microfiber cloth, use a soft bristle brush to remove dirt that could scratch the surface. Then use the microfiber cloth by gently rubbing to clean. Never use window cleaners or solvents. Periodically hand wash the microfiber cloth separately, using mild soap. Do not use bleach or fabric softener. Rinse thoroughly and air dry before next use.

Notice: Do not attach a device with a suction cup to the display. This may cause damage and would not be covered by the warranty.

Radio

AM-FM Radio

Playing the Radio

 /  (Volume/Power):

- Press to turn the radio on or off.
- Turn to increase or decrease the volume of the active source.

The steering wheel controls can also be used to adjust the volume. See *Steering Wheel Controls* on page 8.

Radio Operation

The radio will work when the key is in ON/RUN or ACC/ACCESSORY. When the key is turned from ON/RUN to LOCK/OFF, the radio will continue to work for 10 minutes or until the driver door is opened.

The radio can be turned on by pressing the power button on the radio and will stay on for 10 minutes. Opening the driver door will not turn the radio off when pressing the power button.

Some radios may stay on longer and reset the time for 10 minutes if there are any additional presses of any radio button.

The radio can be turned off at any time by pressing the power button.

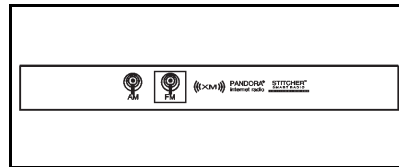

Audio Source

Press SRCE to display and scroll through the available sources AM, FM, XM (if equipped), Pandora, Stitcher, CD, USB, AUX, and Bluetooth Audio.

Infotainment System Settings

Tone Settings

To access the tone settings, press TONE or the Tone Settings button on the Home Page. Tone settings are specific to each source.

To adjust the settings:

- Bass: Press + or – to change the level.
- Mid (Midrange): Press + or – to change the level.
- Treble: Press + or – to change the level.
- EQ: Press or turn the Menu knob to cycle through the preset EQ options.
- Fade: Press the F or R button for more sound from the front or rear speakers. The middle position balances the sound between the front and rear speakers.

- Balance: Press the L or R button for more sound from the left or right speakers. The middle position balances the sound between the left and right speakers.

Finding a Station

Press SRCE or SRC on the steering wheel controls to select AM, FM, XM (if equipped), Pandora, Stitcher, CD, USB, AUX, and Bluetooth Audio.

Turn the Menu knob to find a radio station. To select a preset station, press FAV 1/2/3 to scroll through the favorite pages and then press a preset button on the radio or the screen button.

Seeking a Station

Press ◀◀◀ or ▶▶▶ to search for a station.

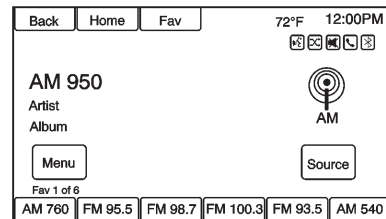

AM

1. Press the AM screen button on the Home Page or select AM by pressing SRCE or SRC on the steering wheel controls, or say “Tune AM” or “AM” through voice recognition.
2. Press the Menu screen button to display the AM stations or categories.
3. Press to select an option. To update the station list, press Refresh.

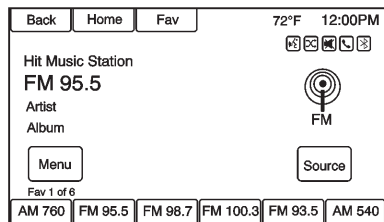

FM

1. Press the FM screen button on the Home Page or select FM by pressing SRCE or SRC on the steering wheel controls, or say "Tune FM" or "FM" through voice recognition.
2. Press the Menu screen button to display the FM stations or categories.
3. Press to select an option. To update the station list, press Refresh.

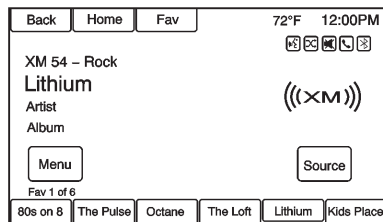

XM (If Equipped)

1. Press the XM screen button on the Home Page or select XM by pressing SRCE or SRC on the steering wheel controls, or say "Tune XM" or "XM" through voice recognition.
2. Press the Menu screen button to display the XM categories.
3. Press a category and then turn the Menu knob to scroll the station list. Press to select an option.

Storing Radio Station Presets

Up to 36 preset stations can be stored. AM, FM, and XM (if equipped) can be mixed.

1. From the AM, FM, or XM main page, press and hold any of the 1–6 buttons or one of the preset screen buttons at the bottom of the screen. After a few seconds, a beep is heard and the new preset information displays on that screen button.
2. Repeat for each preset.

Mixed-Band Presets

Each favorite page can store six preset stations. The presets within a page can be different radio bands.

To scroll through the pages, press FAV 1/2/3 or the Fav screen button on the top bar. The current page number displays above the preset buttons. The stored stations for each favorite page display on the preset buttons.

To change the number of favorite pages displayed:

1. Press Config on the Home Page.
2. Press Radio Settings.
3. Press Number of Favorite Pages.

Recalling a Preset Station

To recall a preset station from a favorites page, do one the following:

- Press the Fav screen button at the top bar to display the preset pop-up. Press one of the preset screen buttons to go to the selected preset station.
- In the AM, FM, or XM (if equipped) main page, press one of the preset screen buttons to go to the selected preset station.

Radio Data System (RDS)

RDS features are available for use only on FM stations that broadcast RDS information. With RDS, the radio can:

- Seek to stations broadcasting the selected type of programming.
- Receive announcements concerning local and national emergencies.
- Display messages from radio stations.

This system relies on receiving specific information from these stations and only works when the information is available. It is possible that a radio station could broadcast incorrect information that causes the radio features to work improperly. If this happens, contact the radio station.

When information is broadcast from the current FM station, the station name or call letters display on the audio screen. RDS can provide a program type (PTY) for current programming and the name of the program being broadcasted.

Satellite Radio

SiriusXM® Satellite Radio

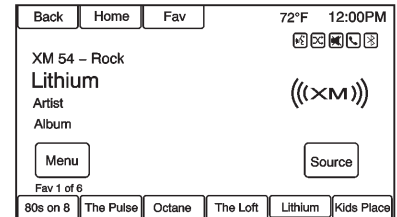

Vehicles with a valid SiriusXM satellite radio subscription can receive SiriusXM programming.

18 Infotainment System

SiriusXM satellite radio has a wide variety of programming and commercial-free music, coast to coast, and in digital-quality sound. See www.siriusxm.com or call 1-866-635-2349 (U.S.) and www.xmradio.ca or call 1-877-209-0079 (Canada).

When SiriusXM is active, the station name, number, category name, song title, and artist display on the screen. SiriusXM may update the background picture at any time.

Press the XM icon on the Home Page to access the XM Audio Menu.

TuneSelect

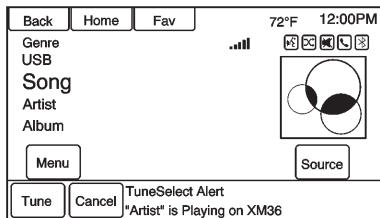

An alert will be sent when the radio sees that search criteria on any XM channel is met and offer the option to tune to that song or artist. Up to ten artists and songs can be saved in the TuneSelect list.

To store an Artist or Song:

1. Press Menu when the Artist or Song is on XM.
2. Select TuneSelect.

3. Select Save Alert for Artist Playing or Save Alert for Song Playing.

4. Press OK to confirm.

To turn TuneSelect On or Off

1. Press Menu when in XM.
2. Select TuneSelect.
3. Select Alerts Active to turn the alerts on or off.

To delete TuneSelect Alerts:

1. Press Menu when in XM.
2. Press Manage TuneSelect.
3. Press Delete Alerts.
4. Select the alert to delete.
5. Press OK to confirm.

SiriusXM Categories

SiriusXM stations are organized in categories.

Adding or Removing XM Categories

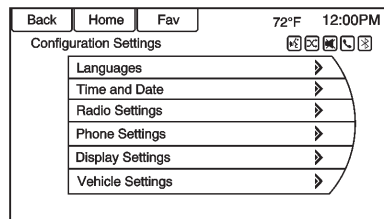

To customize which XM categories are used and displayed in the system:

1. Press CONFIG or the Config screen button on the Home Page.
2. Select Radio Settings from the Settings Menu list.
3. Select XM Categories.

4. Select or deselect any category to be used in XM mode. A checkmark will indicate that the category is selected.

Press Show All XM Categories to restore all XM categories.

SiriusXM Channel Graphics

SiriusXM provides updated category background graphics and the radio will automatically update the screen. SiriusXM may send updated category graphics to the vehicle. When this happens, the background graphics may appear to be incorrect but the radio will update once all of the graphics have been downloaded from SiriusXM.

To turn SiriusXM channel graphics on or off:

1. Press HOME on the faceplate.
2. Select XM.
3. Press Menu on the XM Now Playing Screen.
4. Press XM Channel Graphics to turn on or off.

SiriusXM Messages

XL (Explicit Language Channels): These stations, or any others, can be blocked by request, by calling 1-866-635-2349 (U.S.) and 1-877-209-0079 (Canada).

XM Updating: The encryption code in the receiver is being updated. No action is required.

Loading XM: The audio system is acquiring and processing audio and text data. No action is needed.

Channel Off Air: This station is not currently in service.

Channel Unauth: This station is blocked or cannot be received.

Channel Unavailable: This previously assigned station is no longer assigned.

No Artist Info: No artist information is available at this time on this station.

No Title Info: No song title information is available at this time on this station.

20 Infotainment System

No CAT Info: No category information is available at this time on this station.

No Information: No text or informational messages are available at this time on this station.

No XM Signal: The vehicle may be in a location where the SiriusXM signal is being blocked. When the vehicle is moved into an open area, the signal should return.

CAT Not Found: There are no stations available for the selected category.

XM Radio ID: If tuned to station 0, this message alternates with the SiriusXM radio eight-digit radio ID label. This label is needed to activate the service.

Unknown: If this message is received when tuned to station 0, there could be a receiver fault. Consult with your dealer.

Check Antenna: If this message does not clear within a short period of time, the receiver could have a fault. Consult with your dealer.

XM Not Available: If this message does not clear within a short period of time, the receiver could have a fault. Consult with your dealer.

NavTraffic® (If Equipped)

The navigation system might have a SiriusXM NavTraffic receiver. It is a subscription service provided through SiriusXM Satellite Radio. A service fee is required to receive the SiriusXM NavTraffic service. Real-time traffic information is provided to fully integrate the navigation system to display current traffic conditions for the chosen route. See "Traffic Settings" in this section for more information.

A screen displays to indicate that the SiriusXM NavTraffic subscription is not activated.

If activated, traffic information displays:

- Unscheduled traffic incident data, such as accidents and disabled vehicles.
- Scheduled traffic incident data, such as road construction and road closures.
- Traffic flow information (rate of speed data). Flow data might not be available in all markets.

Traffic information is delivered to the vehicle by the SiriusXM Radio satellites. SiriusXM NavTraffic provides continuously updated traffic information.

SiriusXM NavTraffic currently broadcasts the traffic information for many markets nationally. The service may be available in more cities in the future. Visit www.xmnavtraffic.com for more details on local coverage.

To access the traffic features, press the Traffic button from the Navigation Menu or map screen.

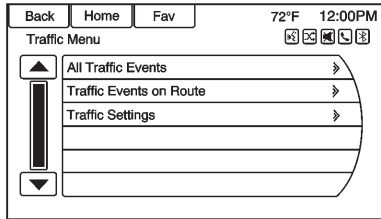

All Traffic Events: Press to view a list of reported traffic conditions for up to approximately 100 km (70 mi). It could take some time to display the information received.

The information is displayed with an arrow and distance. The arrow indicates the distance in a straight line and the direction of the event from the vehicle's current position.

Traffic Events on Route: Press to display a list of reported traffic conditions on the current route. The button is toned down if no route is active.

Traffic Settings: Press to customize traffic options.

Travel Link (If Available)

The infotainment system may have SiriusXM Travel Link[®]. It is a subscription service provided through SiriusXM Satellite Radio. A service fee is required to receive the SiriusXM Travel Link service. When subscribed to SiriusXM Travel Link, one or more services may be available.

- **Travel Link Fuel Prices:** Detailed nation wide fuel price information may be available.
- **Travel Link Movie Listings:** Detailed local movie theater listings, start times, and ratings may be available.

- **Travel Weather:** National and Local Weather gives current and forecasted weather.

For more detailed information and coverage details on SiriusXM Travel Link go to www.siriusxm.com.

Fuel Pricing

When SiriusXM Travel Link information is available, the system will display a list of fuel stations close to the vehicle location. The list will include fuel station name, direction, distance and price. The list can be sorted by distance or price and there are four different fuel types to choose from. As the vehicle is moving a direction arrow and distance to fuel station will update. The arrow represents the direction to the gas station from the current vehicle position. The distance represents the straight line distance between the vehicle location and the fuel station.

22 Infotainment System

From the Home Page, press the SiriusXM® Fuel button. The system displays the current weather page.

To change the fuel information on screen press the Fuel Menu Button to:

- Sort Fuel Stations By Price or By Distance: The default sort method is by distance.
- Choose Fuel Type: The fuel available fuel types are Regular (unleaded), Mid-Range, Premium, and Diesel.

For more information on the fuel station, select the fuel station name. The screen will show the fuel station name, address, phone number, distance, amenities and the last time the fuel price was updated. If a fuel station does not appear in the list it may be new or the price may not have been updated in the past 24 hours.

If equipped with Navigation when the fuel station is selected, see *Destination on page 54* for more information of navigation routing features.

Allow up to 5 minutes after turning on the vehicle for the fuel information to appear.

Movie Listings

When SiriusXM Travel Link information is available the movie feature provides movie show time and theater information for movies close to the vehicle location. The Movie feature provides detailed theater and movie information including showtimes.

From the Home Page, press the SiriusXM® Movie button. The system displays the Movie and Theater search page.

To search movies:

- Select the Movie field to choose a movie name.
- Select the Theater field to choose a specific theater.
- Select the Date field to choose which date to search movie and/or theaters.
- Press the Search button to view a list of movies or theaters.

When searching by movie, a list will display movies to select. When a movie is selected a theater list will appear with a direction arrow and distance from the current vehicle location. The direction and distance will update every ten seconds as the vehicle is moving. The direction arrow represents the location of the theater from the current vehicle location. The distance represents the straight line distance between the vehicle location and the theater.

Movie details are available when a movie is selected. The details include Cast, Synopsis, and Theater Information. Select the appropriate button to display more information.

Cast and Synopsis:

- Playtime
- Rating (G, PG-13, R, etc.)
- Theater Name
- Showtimes

Theater information includes address, phone number, distance, and amenities.

National and Local Weather

Whether near home or on a long road trip, detailed weather information is available. SiriusXM Travel Link Weather uses the same sources that professional pilots and mariners rely on.

From the Home Page, press the SiriusXM Weather screen button. The system displays the current weather page.

Current Condition

The current weather page shows the current weather condition in the city of the vehicle's current position. On this page, select the Menu screen button to access other weather options, such as Extended Forecast, Weather Along the Route, Weather Around Other Cities, and Weather Alerts. Some options may only be present on vehicles equipped with navigation.

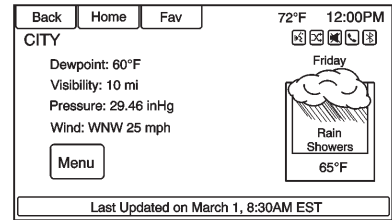

Allow approximately 15 minutes for the current weather in the area to display.

Extended Forecast

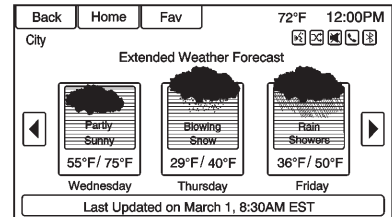

Press to show the extended forecast.

Weather Along the Route

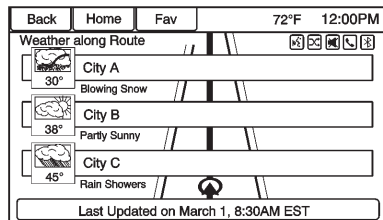

If a destination is set, there is the option to view weather conditions for up to three locations along the route:

- Current vehicle position.
- Midway point from current position to final destination.
- Current weather condition of the destination city.

Weather Alerts

From the XM Weather Menu, press the Weather Alerts screen button to display any current weather advisory warnings in effect near the current position.

Weather Around Other Cities

Select this option to view weather conditions around or in a specific city entered by name or selected from the map.

Restore to Current Location

Press the Restore Current Location screen button to display the weather condition for the city where the vehicle is currently located, if the system was modified to view weather conditions in another city.

Troubleshooting

XM Travel Link services use the SiriusXM[®] Satellite Signal and GPS Satellite Signal to provide this feature.

When the vehicle is started, it can take up to five minutes for the radio to receive the Travel Link services.

Travel Link Messages

No GPS Signal: Move the vehicle into a position that is visible to the sky.

Acquiring Signal: Radio is downloading the activation information or not receiving a good signal. Move the vehicle to open sky and restart the vehicle.

No XM Signal: Reception is blocked. Move the vehicle into open sky.

Radio Reception

Frequency interference and static can occur during normal radio reception if items such as cell phone chargers, vehicle convenience accessories, and external electronic devices are plugged into the accessory power outlet. If there is interference or static, unplug the item from the accessory power outlet.

FM

FM signals only reach about 16 to 65 km (10 to 40 mi). Although the radio has a built-in electronic circuit that automatically works to reduce interference, some static can occur, especially around tall buildings or hills, causing the sound to fade in and out.

AM

The range for most AM stations is greater than for FM, especially at night. The longer range can cause station frequencies to interfere with each other. Static can occur when things like storms and power lines interfere with radio reception. When this happens, try reducing the treble on the radio.

SiriusXM® Satellite Radio Service

SiriusXM Satellite Radio Service gives digital radio reception from coast to coast in the 48 contiguous United States, and in Canada.

Just as with FM, tall buildings or hills can interfere with satellite radio signals, causing the sound to fade in and out. In addition, traveling or standing under heavy foliage, bridges, garages, or tunnels may cause loss of the SiriusXM signal for a period of time.

Cellular Phone Usage

Cellular phone usage can cause interference with the vehicle's radio.

Backglass Antenna

The AM-FM antenna is integrated with the rear window defogger in the rear window. Do not scratch the inside surface or damage the lines in the glass. If the inside surface is damaged, it could interfere with radio reception. For proper radio reception, the antenna connector needs to be properly attached to the post on the glass.

If attaching a cell phone antenna to the glass, attach it between the grid lines.

Notice: Using a razor blade or sharp object to clear the inside rear window can damage the rear window antenna and/or the rear window defogger. Repairs would not be covered by the vehicle warranty. Do not clear the inside rear window with sharp objects.

Notice: Do not apply aftermarket glass tinting with metallic film. The metallic film in some tinting materials will interfere with or distort the incoming radio reception. Any damage caused to the backglass antenna due to metallic tinting materials will not be covered by the vehicle warranty.

Quick Info

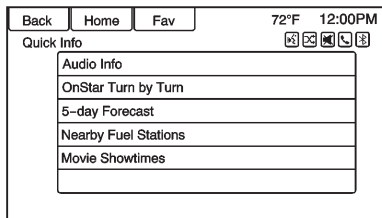

Quick Info gives access to quick information on Audio playing, OnStar Turn-by-Turn route (if equipped), 5-day forecast, Nearby Fuel Stations, and Movie Show Times.

To access, press Quick Info on the Home Page or the INFO button on the faceplate. Depending on the system and if the options are available for that region, some options may be grayed out.

Audio Info: Displays information on current item playing.



OnStar Turn-by-Turn: Displays the next maneuver in a route. See *OnStar® Destination Download on page 63*.

5-day Forecast: Displays the 5-day forecast for the weather station closest to the current location. See “Weather (If Equipped)” in *Satellite Radio on page 17*.

Nearby Fuel Stations: Displays fuel prices and distances for close fuel stations. See “Fuel Pricing” under “Travel Link (If Available)” in *Satellite Radio on page 17*.

Movie Showtimes: Displays a list of movies playing in the theaters closest to current location. See “Movie Listings” in *Satellite Radio on page 17*.

Pandora Internet Radio

Pandora® (if equipped) is a free Internet radio service that streams personalized radio stations based on artists, songs, genres, and comedians. Create stations using the Pandora website or smartphone application, then use  (thumbs up) or  (thumbs down) to personalize stations. To set up an account, or for more information, go to www.pandora.com. Pandora may not be available in Canada or Mexico.

A phone or tablet with Internet connection and the Pandora application installed is required. Personal cell phone data plans are used. Make sure the latest version is installed on the device and the volume is turned up.



To install Pandora:

- On an Android™ phone or Android Tablet, go to the Android Play Store, search for Pandora. Install to the phone, not to the SD card.
- On a BlackBerry® phone, go to the BlackBerry App World™ and search for Pandora.
- On an iPhone®, iPad®, or iPod touch®, go to the iTunes® Store and search for Pandora.

Launching Pandora

Connect the iPhone, iPad, or iPod touch to the USB port, or connect an Android or BlackBerry through Bluetooth. See *Auxiliary Devices on page 45* or *Bluetooth on page 79*. For first-time use, set up stations before connecting to the vehicle. The Pandora icon will be available on the Home Page and the source pop-up displays if the latest application is installed on the device.

Using the iPhone, iPod touch, or iPad

1. Plug the device into the USB port. The phone screen must be unlocked.
2. To launch, do one of the following:
 - Launch the application on the device.
 - Press Pandora on the Home Page.
 - Press  /  and say "Pandora" or "Tune Pandora."

To relaunch Pandora, press SRCE on the faceplate or SRC on the steering wheel controls.

If nothing happens when the available Pandora screen button is pressed, download the latest Pandora application and retry.

Pandora will always be highlighted on the Home Page when an iPhone, iPad, or iPod touch is connected using the USB port. To use, log into your account.



If the "Please See Device" message is shown, the login screen may display on the device.

If the "Please unlock your phone or restart the app" message is shown, then your phone may be locked. Unlock the phone, close the app, then restart the app and make sure the Home Page is visible on the phone.

If the vehicle is shutoff while tuned to Pandora and the iPhone, iPad, or iPod touch is left connected to the USB port before the next ignition cycle, the radio will start playing Pandora when the vehicle is started.

If Pandora is shut down on the phone or another audio app is used, Pandora may not start on the next ignition cycle. If iPod source is selected, it may show iPod and then switch to Pandora.

Using an Android Phone

1. Pair the Android phone using Bluetooth.
2. Use one of the following to launch:
 - Launch the application on the device.
 - Press Pandora on the Home Page.
 - Press  /  and say "Pandora" or "Tune Pandora."

After Pandora has been launched, press SRCE on the faceplate or SRC on the steering wheel controls to access Pandora features.



If nothing happens when the available Pandora screen button is pressed, download the latest Pandora application and retry.

If the "Please See Device" message is shown, the login screen may display on the device.

If the "Please unlock your phone or restart the app" message is shown, then your phone may be locked. Unlock the phone, close the app, then restart the app to ensure proper communication.

Using a BlackBerry Phone

The phone must be unlocked. To launch Pandora service:

1. Pair the BlackBerry phone using Bluetooth.
2. Use one of the following to launch:
 - Launch the application on the device.
 - Press Pandora on the Home Page.
 - Press  /  and say "Pandora" or "Tune Pandora."

After Pandora has been launched, press SRCE on the faceplate or SRC on the steering wheel controls to access Pandora features.

If nothing happens when the available Pandora screen button is pressed, download the latest Pandora application and retry.

If the "Please See Device" message is shown, the login screen may display on the device.

If the "Please unlock your phone or restart the app" message is shown, then your phone may be locked. Unlock the phone, close the app, then restart the app to ensure proper communication.

Pandora Menus

Press Menu on the Pandora main page.

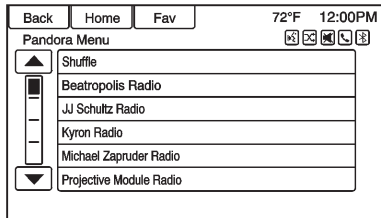

Pandora has a menu system with the following:

Shuffle: Press to play the stations in random order.

User-Created Stations: Press to play a user-created station.

Pandora Features

Pandora has features to rate tracks, skip tracks, or change stations.

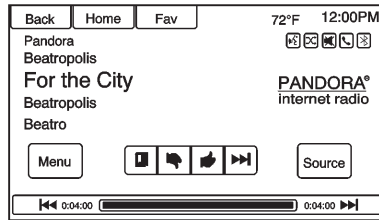

⏏ (Bookmarks): Press while playing a track to bookmark either the track or the artist. Bookmarks are viewable on www.pandora.com.

👎 (Thumbs Down): When pressed, Pandora stores the information, changes to the next track, and does not play the track on this station again. This helps Pandora choose which tracks should not play on this station. This feature is only available on user created stations.

👍 (Thumbs Up): When pressed, Pandora stores this information and 👍 is highlighted for the remainder of the track. This helps Pandora choose which tracks should play on this station.

▶▶ (Next Track): When pressed, Pandora changes to the next track.



▶ || (Play/Pause): Press on the radio to pause playback. Press again to resume.

Tuning Pandora Stations: When Pandora is playing, use the  button on the steering wheel to tune to any Pandora Station on the device.

1. Press the  button on the steering wheel.
2. Say "Tune Pandora <Classic Rock> Radio."

Pandora voice control will not work until Pandora is launched the first time during that ignition cycle.

Pandora Skip Limit

Pandora limits the number of skips allowed on their service. When the skip limit is reached,  will not skip the currently playing track, but  feedback will be recorded.

Pandora Advertisement

Pandora may display advertisements. Artist name and track title will not be displayed and the skip track button is not available.

Switching Between Pandora and Stitcher

To switch between Pandora and Stitcher, press the application icon on the iPhone, iPod touch, or iPad. This is not required for Android devices. See *Stitcher Internet Radio* on page 32.

Pandora Troubleshooting

Unable to Connect Device to Vehicle

If the device is unable to connect to the USB or Bluetooth:

1. Turn the vehicle off.
2. Remove the key from the ignition.
3. Open and close the driver door, wait about 30 seconds, and try to connect the device again.



Unable to Start Pandora

If the device is unable to launch Pandora:

- Check that the latest version of Pandora is installed.
- Check that there is an active account logged into Pandora.
- Have at least one station created.

- For Android and BlackBerry devices, check that the device is paired with the vehicle, and the Bluetooth icon on the display is highlighted.
- For iPhone, iPod touch, or iPad devices, check that the USB cable is connected to the USB port and the screen is unlocked.
- Close Pandora on the device and launch again. Devices that allow multitasking may require an extra step to quit the Pandora application. See the cell phone manufacturer's user guide.

Thumbs Up or Thumbs Down Error

If there is an error trying to rate a track with the  or  buttons, the message "Thumbs Down Error" or "Thumbs Up Error" will display. Press OK to retry.

Loss of Audio

Loss of Pandora audio can happen in different ways:

- Weak or lost data connection.
- Device needs to be charged.
- Application needs to be relaunched.
- Connection between phone and radio lost.
- If any iPhone, iPod touch, or iPad is connected to Bluetooth and the dock connector, go to the Airplay icon on the device and select dock connector or disconnect and reconnect the dock connector on the device.
- The volume is too low. Turn up the volume on the device.
- The battery saver and task manager applications on the phone can cause Pandora to function incorrectly. Remove

those apps from the phone or remove Pandora and Bluetooth from the task lists.

If the connection is lost between the application and device, a message "Please unlock your phone or restart the phone app and try again" will display. Press OK to retry.

If pressing OK does not clear the issue on the phone, see "Please Unlock Your Phone or Restart Phone App and Try Again" under "Common Pandora Messages" following.

Common Pandora Messages

Please See Device: When not logged in or when authentication failed, see the device. Press OK to continue.

Paused or Audio Paused: Playback is paused on the radio or device. Press ▷/|| or play on the device.

No Stations Found: Logged in but no stations created. Press OK to continue.

Please Unlock Your Phone or Restart Phone App and Try Again: Communication failure between the radio and the phone application or the device is locked.

Devices that allow multitasking may require an extra step to quit the Pandora application. Close Pandora on the device and launch again.

Unlock the phone and check that Home Page is shown on the phone/device.

See the cell phone manufacturer's user guide.

See www.pandora.com/help for more information. If the service will not work, see your dealer for assistance.

Stitcher Internet Radio

Stitcher SmartRadio™ is an Internet radio service that streams news, sports, and entertainment shows through the audio system. Create personalized, on-demand stations or discover new shows through Stitcher's preset stations. To set up an account, download the application from the Android Market or iTunes Store, or go to www.stitcher.com.

A phone or tablet with Internet connection is required for this application. Personal cell phone data plans are used. Make sure the latest version is installed on the device and the volume on the device is turned up.

BlackBerry phones are not supported for this application.



To install Stitcher:

- On an Android phone or Tablet with Internet connection, go to the Android Play Store, search for Stitcher, and install to the phone, not to the SD card.
- On an iPhone, iPad, or iPod touch, go to the iTunes store and search for Stitcher.

Launching Stitcher

Connect the iPhone, iPad, or iPod touch to the USB port, or connect Android through Bluetooth. See *Auxiliary Devices on page 45* or *Bluetooth on page 79*. For first time use, set up the stations before connecting to the vehicle. The Stitcher icon will be available on the Home Page and source pop-up displays if the latest application is installed on the device.

Using the iPhone, iPod Touch, or iPad

1. Plug the device into the USB port. The phone screen must be unlocked.
2. Use one of the following to launch:
 - Press the application on the device.
 - Press Stitcher on the Home Page.
 - Press  /  and say "Stitcher" or "Tune Stitcher."
3. If Stitcher does not begin playing, select a category and then a station.

After Stitcher has been launched, press SRCE on the faceplate or SRC on the steering wheel controls to access Stitcher features.

If nothing happens when the available Stitcher screen button is pressed, download the latest Stitcher application and retry.



Stitcher will always be highlighted on the Home Page when an iPhone, iPad, or iPod touch is connected using the USB port. To use, log into your account.

If the “Please See Device” message is shown, the login screen may display on the device.

If the “Please unlock your phone or restart the app” message is shown, then the phone may be locked. Unlock the phone, close the app, then restart the app and make sure the Home Page is visible on the phone/device.

Using an Android Phone

1. Pair the Android phone using Bluetooth.
2. Use one of the following to launch:
 - Press the application on the device.
 - Press Stitcher on the Home Page.

- Press  /  and say “Stitcher” or “Tune Stitcher.”

3. If Stitcher does not begin playing, select a category and then a station.

After Stitcher has been launched, press SRCE or SRC on the steering wheel controls to access Stitcher features.

If nothing happens when the available Stitcher screen button is pressed, download the latest Stitcher application and retry.

If the “Please See Device” message is shown, the login screen may display on the device.

If the “Please unlock your phone or restart the app” message is shown, then your phone may be locked. Unlock the phone, close the app, then restart the app to ensure proper communication.

Stitcher Menus

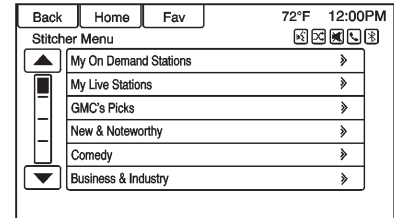

Press Menu on the Stitcher main page.

Stitcher has a menu system with the following:

My On Demand Stations: Displays a list of favorite stations and shows.

Select and store programs as favorites on the device. Favorite station lists can be created to include favorite shows which can be accessed through My On Demand Stations.

Stitcher Station Categories:

Displays categories by topic.

When a category then sub-category is selected, the radio will start playing the first program in that sub-category.

Turn the Menu knob to bring up the first 24 stations of that subcategory.

Current Station Playlist: While listening to a show, turn the Menu knob to display the menu list of shows available for the current station.

Stitcher Features

Stitcher service has features to rate or skip shows, or change stations.

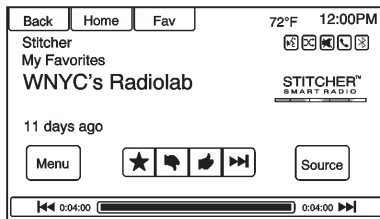

★ **(Favorites):** When pressed, the current show is added to the favorites station.

👎 **(Thumbs Down):** When pressed, Stitcher changes to the next show. This helps Stitcher provide a personalized listening experience.

👍 **(Thumbs Up):** When pressed, Stitcher stores this information and 👍 is highlighted for the remainder of the show. This helps Stitcher provide a personalized listening experience.

▶▶ **(Next Show):** When pressed, Stitcher changes to the next show.

▷ || **(Play/Pause):** Press on the radio to pause playback. Press again to resume.

Stitcher Advertisement

Stitcher may display advertisements. Artist name and title may not display and the skip track button is not available.

Switching Between Pandora and Stitcher

To switch between Pandora and Stitcher, press the application icon on the iPhone, iPod touch, or iPad. This is not required for Android devices. See *Pandora Internet Radio on page 26*.

Stitcher Troubleshooting

Unable to Connect Device to Vehicle

If the device is unable to connect to the USB or Bluetooth:

1. Turn the vehicle off.
2. Remove the key from the ignition.
3. Open and close the driver door, wait about 30 seconds, and try to connect the device again.

The battery saver and task manager applications on the phone can cause Stitcher to function incorrectly. Remove those apps from the phone or remove Stitcher and Bluetooth from the task lists.

Unable to Start Stitcher

If the device is unable to launch Stitcher:

- Check that the latest version of Stitcher is installed.
- Check that there is an active account logged into Stitcher.

- For Android devices, check that the device is paired with the vehicle, and the Bluetooth icon on the display is highlighted.
- For iPhone, iPod touch, or iPad devices, check that the USB cable is connected to the USB port and the screen is unlocked.
- Close Stitcher on the device and launch again. Devices that allow multitasking may require an extra step to quit the Stitcher application. See the cell phone manufacturer's user guide.

Loss of Audio

Loss of Stitcher audio can happen due to:

- Weak or lost data connection.
- Device needs to be charged.
- Application needs to be relaunched.
- Connection between phone and radio is lost.

- If any iPhone, iPod touch, or iPad is connected to Bluetooth and the dock connector, go to the Airplay icon on the device and select dock connector or disconnect and reconnect the dock connector on the device.
- The volume is too low. Turn up the volume on the device.

If the connection is lost between the application and device, a message "Please unlock your phone or restart the phone app and try again" will display. Press OK to retry.

If pressing OK does not clear the issue, see "Please unlock your phone or restart phone app and try again" under "Common Stitcher Messages" following.

Common Stitcher Messages

Please Try Again Later: A general error has occurred. A data connection may be unavailable due to a weak or lost signal or the Stitcher service being temporarily down. Press OK to continue.

Paused or Audio Paused:

Playback is paused on the radio or device. Press \triangleright/\parallel or play on the device.

Please See Device: When the user is not logged in or when authentication failed, see device. Press OK to continue. Disconnect the phone from the radio and follow the Stitcher account login process on the phone.

No Stations Found: Logged in but no stations have been created. Press OK to continue.

Please Choose a New Station: The end of the station has been reached and there is no more content to play. Select a new station through the Stitcher menu.

Please Unlock Your Phone or Restart Phone App and Try Again: Communication failure between the radio and the phone application or the device is locked.

See www.stitcher.com/help for more information. If the service will not work, send an e-mail to feedback@stitcher.com or see your dealer for assistance.

Pictures

Pictures can only be viewed using USB devices. If pictures are on an SD card, transfer to a USB device or use a USB-SD adapter. File sizes above approximately four mega pixels may not show. Only jpeg, bmp, gif, and png files are supported.

1. Press the Pictures screen button on the Home Page.
2. The system does a search to find the picture folders. A "Please wait" message displays until the search is finished.

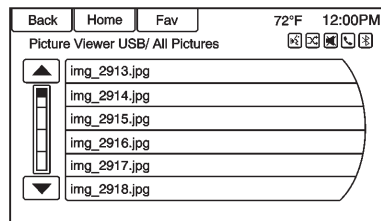

3. A list displays. Select a picture to view.

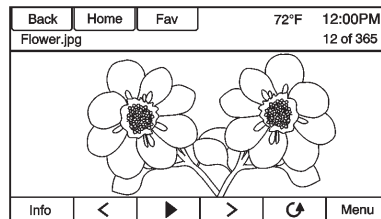

4. Once a picture displays, the following options are available:

Info: Press to turn file name information on or off.

\triangleleft : Press to display a previous picture if not in slide show mode.

▶ : Press to toggle between slide show mode and manual mode.

> : Press to display a next picture if not in slide show mode.

↶ : Press to manually rotate a picture 90 degrees counterclockwise.

Menu: Press to open the Picture Viewer Settings screen. Slide Picture Viewer Main, Slideshow Timer, and Shuffle Images display as options for configuring the view of images stored in the system.

If the displayed picture screen is not used within six seconds, the upper and lower bar options will disappear. Touch-tap the screen to re-display the upper and lower bar.

Audio Players

CD Player

The CD player is capable of playing:

- Most audio CDs
- CD-R
- CD-RW
- MP3, unprotected WMA, and AAC formats

When playing any compatible recordable disc, the sound quality may be reduced due to the disc, the method of recording, the quality of the music recorded, or how the disc has been handled.

There may be increased skipping, difficulty reading recorded tracks, finding tracks, and/or loading and ejecting. If these problems occur, check the disc for damage or try a known good disc.

To avoid damage to the CD player:

- Do not use scratched or damaged discs.
- Do not apply labels to discs. The labels could get caught in the player.
- Insert only one disc at a time.
- Keep the loading slot free of foreign materials, liquids, and debris.
- Use a marking pen to label the top of the disc.

Loading and Ejecting Discs

To load a disc:

1. Turn the vehicle on.
2. Insert a disc into the slot, right side up. The player pulls it in the rest of the way. If the disc is damaged or improperly loaded, there is an error and the disc ejects.

The disc automatically plays once loaded.

Press  to eject a disc from the CD player. If the disc is not removed within a short period of time, it is automatically pulled back into the player.

Playing an Audio CD

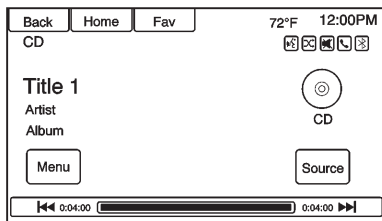

1. Press the CD screen button on the Home Page or select CD from the source pop-up to display the CD main page.
2. Press the Menu screen button to display the menu options.
3. Press to select the option.

On the CD main page, the track number displays and the Song, Artist, and Album information displays when available.

Use the following radio controls to play the disc:

 **(Play/Pause):** Use to pause or resume play.

 **(Previous/Reverse):**

- Press to seek to the beginning of the current or previous track. If the track has been playing for less than five seconds, it seeks to the previous track. If longer than five seconds, the current track starts from the beginning.
- Press and hold to fast reverse through a track. Release the button to return to playing speed. Elapsed time displays.

 **(Next/Fast Forward):**

- Press to seek to the next track.
- Press and hold to fast forward through a track. Release the button to return to playing speed. Elapsed time displays.

Menu Knob: Turn to the right or left to select the next or previous track. Press this knob to select from the list. If a track is selected from the menu, the system plays the track and returns to the CD screen.

Error Messages

If Disc Error displays and/or the disc comes out, it could be due to:

- The disc has an invalid or unknown format.
- The disc is very hot. Try the disc again when the temperature returns to normal.
- The road is very rough. Try the disc again when the road is smoother.

- The disc is dirty, scratched, wet, or upside down.
- The air is very humid. Try the disc again later.
- There was a problem while burning the disc.
- The label is caught in the CD player.

If the CD is not playing correctly, try a known good CD.

If any error continues, contact your dealer.

USB

Playing from a USB

A USB mass storage or Certified Windows Vista®/Media Transfer Protocol (MTP) device can be connected to the USB port.

The USB port is in the center console.

The USB icon displays when the USB device is connected.

USB Media Formats

The USB port will support the following media formats:

- MP3
- Unprotected WMA
- Unprotected AAC

Gracenote®

Gracenote technology embedded into the radio helps manage and navigate the USB device music collection. When a USB device is connected to the radio, Gracenote identifies the music collection and delivers the correct album, artist name, genres, and cover art on the screen. If information is missing, Gracenote will fill it in.

Searching Music Library Using Voice Recognition

Voice Recognition: Gracenote improves music search and navigation by identifying bands, artists, and albums names that may be hard to pronounce, irregular spellings, and nicknames. For example, Gracenote helps the system understand artist names like "INXS" or "Mötley Crüe." It also allows the use of names like: "The Boss," "G.N.R.," "The Fab Four," and thousands of other famous artist nicknames as voice commands to access music. See *Voice Recognition* on page 72.

Normalization: Normalization helps to improve the voice recognition accuracy for titles that sound similar. It also helps group long lists of genres into 10 common genres. For example, there may be multiple rock genres in the media library; normalization will group all those into one rock Genre. Normalization default is off.

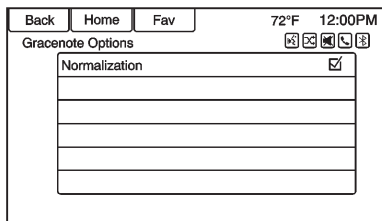

To turn Normalization on:

1. Press CONFIG or Config on the Home Page.
2. Press Radio Settings, then press Gracenote Options.
3. Press Normalization to turn on or off.

Cover Art: The Gracenote embedded database contains cover art or album art information for the music on the USB device. If the music is recognized by Gracenote and does have cover art, Gracenote will use the cover art found in the embedded database and display it on the radio. User predefined cover art will always be used first. If no cover art is found Gracenote will use generic Genre graphics or images of artists.

More Like This

The Gracenote database contains attributes for Music, such as genre, era of music, region, artist type, mood, etc. Use this to create a playlist of up to 30 songs "more like" currently listened to song. This playlist will be stored in the Playlist Menu when the device is reconnected. If songs are removed from the device, the system will simply skip over those songs and play the next available song.

Use the touch screen or voice recognition to create a More Like This Playlist. See "Voice Recognition Commands" in *Voice Recognition on page 72*.



Gracenote Indexing

While Gracenote is indexing, infotainment features are available including selecting music from the menu. Voice recognition music will not be available until the radio has completed indexing the device. Devices with more music may take longer to index. The device will index when plugged into the radio for the first time. When Indexing is removed from the screen, the radio is ready to support music search. On the next connection or ignition cycle, Indexing will show briefly on the screen. The radio is searching for changes to the device and preparing the music list. If there are no changes, the voice recognition music search will be available. The radio will index and store two devices with up to 10,000 songs on each device.

USB MP3 Player and USB Drives

- The USB MP3 players and USB drives connected must comply with the USB Mass Storage Class specification (USB MSC).
- Hard disk drives are not supported.
- The radio will not be able to play back write-protected music.
- File systems supported: FAT32, NTFS, Linux, and HFS+.
- The following restrictions apply for the data stored on a USB MP3 player or USB device:
 - Maximum folder structure depth: 8 levels.
 - Maximum number of MP3/WMA files that can be displayed: 10,000.
 - Playlist entries must be in the form of relative paths.
 - The system attribute for folders/files that contain audio data must not be set.

To play a USB device, do one of the following:

- Connect the USB and it begins to play.
- Press the Now Playing screen button on the Home Page.
- Press SOURCE to scroll until the USB source screen is available.
- Press  /  on the steering wheel controls to play CD, Artist, Album, Song Title, or Song Genre. See *Voice Recognition on page 72*.

The following playlist formats are supported:

- M3U (Standard and Extended)
- iTunes
- PLS (Standard)
- WAX
- ASX
- RMP

The radio supports plugging a cell phone in as a USB drive as long as the cell phone supports USB mass storage class or has USB disc drive support enabled.

While the USB source is active, use the following to operate USB function:

Menu Knob: Turn to scroll through the list. Turn quickly to fast scroll alphabetically through large lists.

 **(Play/Pause):** Press to start, pause, or resume play of the current media source.

 **(Previous/Reverse):**

- Press to seek to the beginning of the current or previous track. If the track has been playing for less than five seconds, the previous track plays. If playing longer than five seconds, the current track restarts.
- Press and hold to reverse quickly through playback. Release to return to playing speed. Elapsed time displays.

⏮⏭ (Next/Fast Forward):

- Press to seek to the next track.
- Press and hold to advance quickly through playback. Release to return to playing speed. Elapsed time displays.

USB Menu

The following are available through the USB Menu:

Shuffle: Press to play the tracks randomly. Press again to stop shuffle.

Play More Like This:

1. Press to automatically create a playlist of songs that are like the song currently playing.
2. The radio will show "Playlist Creation Succeeded" and continue playing the current song.

Playlist Creation Failed may appear if a song is not found in the Gracenote Database.

Delete Automatic Playlist: Press to delete a More Like This playlist.

Folders: Press to open a folder list to access the files within the folder structure.

Playlists:

1. Press to view the playlists on the USB.
2. Select a playlist to view the list of all songs in that playlist.
3. Select a song from the list to begin playback.

Artists:

1. Press to view the list of artists on the USB.
2. Select an artist name to view a list of all albums by the artist.
3. To select a song, press All Songs or press an album and then select a song from the list.

Albums:

1. Press to view the albums on the USB.
2. Select the album to view a list of all songs on the album.
3. Select a song from the list to begin playback.

Genres:

1. Press to view the genres on the USB.
2. Select a genre to view a list of all songs of that genre.
3. Select a song from the list to begin playback.

Songs:

1. Press to display a list of all songs on the USB.
2. Songs are displayed as they are stored on the disc. To begin playback, select a song from the list.

File System and Naming

The songs, artists, albums, and genres are taken from the file's song information and are only displayed if present. The radio displays the file name as the track name if the song information is not available.

Playing from an iPod®

This feature supports the following iPod models:

- iPod classic® (6th generation)
- iPod nano® (3G, 4G, 5G, and 6G)
- iPod touch® (1G, 2G, 3G, and 4G)
- iPhone® (2G, 3G, 3GS, 4, and 4S)
- iPad®

There may be problems with the operation and function in the following situations:

- When connecting an iPod on which a more recent version of the firmware is installed than is supported by the infotainment system.
- When connecting an iPod on which firmware from other providers is installed.

To connect an iPod:

1. Connect one end of the standard iPod USB cable to the iPod's dock connector.
2. Connect the other end to the USB port in the center console.

iPod music information displays on the radio's display and begins playing through the vehicle's audio system.

The iPod battery recharges automatically while the vehicle is on. The iPod shuts off and stops charging when the vehicle is shut off.

If the iPod is an unsupported model, it can still be listened to in the vehicle by connecting to the auxiliary input jack using a standard 3.5 mm (1/8 in) stereo cable.

iPod Menu

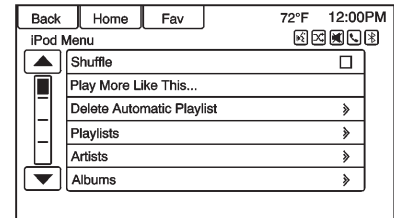

Shuffle: Press to play the tracks randomly. Press again to stop shuffle.

Play More Like This: Allows the radio to create playlists with songs/tracks that are similar to what is being listen to. The radio will create a playlist with up to 30 similar songs. The playlist will appear in the Playlist category of the menu for future listening.

1. Press to automatically create a playlist of songs that are More Like the song currently playing.
2. The radio will show “Playlist Creation Succeeded” and continue playing the current song.

Delete Automatic Playlists: Press to delete a More Like this playlist.

Playlists:

1. Press to view the playlists on the iPod.
2. Select a playlist name to view a list of all songs in the playlist.
3. Select the song from the list to begin playback.

Artists:

1. Press to view the artists on the iPod.
2. Select an artist name to view a list of all albums with songs by the artist.
3. Select an album.
4. Select the song from the list to begin playback.

Albums:

1. Press to view the albums on the iPod.
2. Select an album name to view a list of all songs on the album or select All Songs to view all songs on the iPod.
3. Select the song from the list to begin playback.

Genres:

1. Press to view the genres on the iPod.
2. Select a genre name to view a list of artists of that genre.

3. Select an artist to view albums or All Albums to view all albums of that genre.
4. Select Artist to view albums.
5. Select Album to view songs.
6. Select the song from the list to begin playback.

Songs:

1. Press to view a list of all songs on the iPod.
2. Select the song from the list to begin playback.

Podcasts:

1. Press to view the podcasts on the iPod.
2. Select a podcast name to begin playback.

Composers:

1. Press to view the composers on the iPod.
2. Select the composer to view a list of songs by that composer.

3. Select a song from the list to begin playback.

Audio Books:

1. Press to view the audiobooks on the iPod.
2. Select the audiobook from the list to begin playback.

Playing from an iPhone or iPad

This feature supports iPhone 3G, iPhone 3GS, iPhone 4 and 4S, and iPad.

Follow the same instructions as stated earlier for using an iPod. To use voice recognition to play music, say "Play USB," "Play Artist," "Play Album," "Play Song," or "Play Genre." See *Voice Recognition on page 72*.

iPhone, iPod Touch and iPad Troubleshooting

When an iPhone, iPod touch, or iPad are connected through USB and Bluetooth, the audio may not be heard when the iPod source on the radio is selected. If a phone call is

received while listening to the iPod source and there is no audio for the iPod after the source, then go to the Airplay icon on the device and select dock connector or disconnect and reconnect the dock connector on the device.

Some functionality may differ based on operating system version on device.

USB troubleshooting

If the device is not being recognized or the music is missing screen information, restore the radio defaults:

1. Press Config.
2. Press Vehicle Settings.
3. Press Return to Factory Settings.
4. Press Yes.

Pair the phone again and the device will have to index again.

Bluetooth Audio and Voice Recognition

See *Bluetooth Audio on page 46* and *Voice Recognition on page 72* for information using voice recognition with Bluetooth audio.

Make sure all devices have the latest software downloaded.

Auxiliary Devices

This vehicle has an auxiliary input jack in the center console. Possible auxiliary audio sources include:

- Laptop computer
- MP3 player
- Tape player

This jack is not an audio output. Do not plug headphones into the auxiliary input jack. Set up any auxiliary device while the vehicle is in P (Park).

Connect a 3.5 mm (1/8 in) cable from the auxiliary device to the auxiliary input jack. When a device is connected, the system automatically begins playing audio from the device over the vehicle speakers.

If an auxiliary device has already been connected, but a different source is currently active, do one of the following:

- Press SOURCE to scroll all of the available audio source screens, until the AUX source screen is selected.
- Say “Play Front AUX” using voice recognition to play the auxiliary device. See *Voice Recognition on page 72*.

Bluetooth Audio

If equipped, music may be played from a paired Bluetooth device. See “Pairing a Phone/Device” under *Bluetooth on page 79*.

To play music through a Bluetooth device:

1. Power on the device, pair, and connect the device.
2. Music can be launched by doing one of the following:
 - Press the Bluetooth Audio screen button on the Home Page.
 - Press SOURCE until Bluetooth Audio is selected.
 - Press the SRC button on the steering wheel controls until Bluetooth Audio is selected. See *Steering Wheel Controls on page 8*.
 - Use voice recognition. See *Voice Recognition on page 72*.

The music can be controlled by either the infotainment controls or the controls on the device.

When a phone is connected to the system through Bluetooth Audio the phone notifications and sounds may not be heard on the phone until Bluetooth is disconnected. Notification features may vary based on the phone. Check the phone manufacturer’s information for notification support.

Bluetooth Audio Menu

Press the Menu screen button and the following may display:

Shuffle: Press the Menu knob to turn shuffle on or off. Not all devices support the shuffle feature.

When selecting Bluetooth audio, the Bluetooth device internal music player may not open depending on the status of the device. All devices launch and play back audio differently. Make sure the correct audio source is playing on the device for Bluetooth audio playback on the radio. When the vehicle is not moving, use the device to begin playback.

When selecting Bluetooth audio as a source, the radio may source to the Bluetooth Audio Paused screen with no audio playing. Press play on the device or push **▶/||** to begin playback. This may happen depending on how the device communicates over Bluetooth.

Some phones support sending Bluetooth music information to display on the radio. When the radio receives this information, it will check to see if any album art is available and display it.

When playing music on the radio from a Bluetooth device, make sure the Bluetooth device is unlocked and the intended music application is showing on the home screen.

For iPhone/iPod touch and iPad devices, Bluetooth Audio will not work if the device is connected through the USB and Bluetooth at the same time.

Navigation

Using the Navigation System

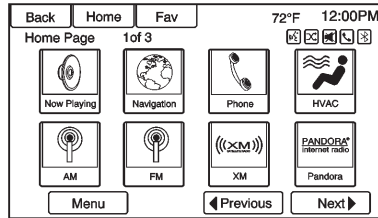

Use the NAV button on the faceplate or Home Page to access the navigation map.

Press the NAV button again to change between alternative views of the normal split and full map views.

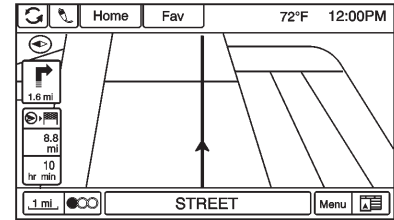

The Menu screen button located at the bottom right side of the display accesses the Navigation Menu.

The touch-sensitive buttons available are:

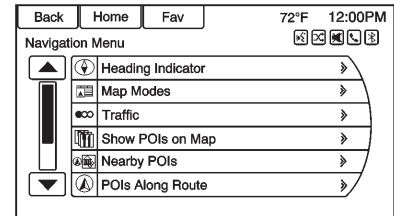

Heading Indicator

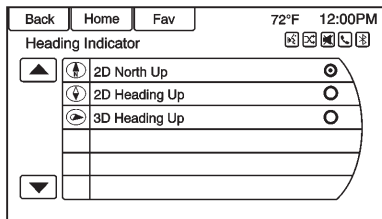

Press Heading Indicator to display the Map View. There are three indicator settings:

- 2D North Up: Displays North at the top of the map screen regardless of the direction the vehicle is traveling.
- 2D Heading Up: Displays the direction the vehicle is traveling. The shaded triangle icon points North.
- 3D Heading Up: Is the same as 2D Heading Up, but the map is in 3D.

Map Modes

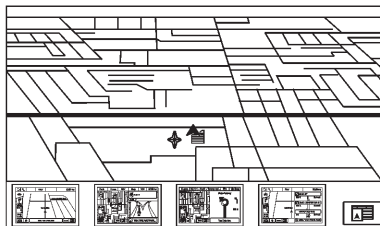

Press to change the view of the maps while using the navigation function. The system offers a variety of full and split views. Some views are only selectable when route guidance is active.



An alternative method to change the view of the maps would be to press the map mode icon.

Traffic

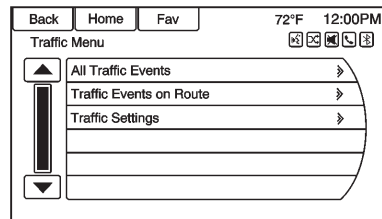

Press Traffic to display the Traffic Menu. Press the desired option.

Options available are:

- All Traffic Events: Press to view all reported traffic events while on or off a planned route.
- Traffic Events on Route: Press to view traffic events while on a planned route.
- Traffic Settings: Press to customize traffic options. This feature can also be accessed by pressing the traffic light screen button displayed at the left lower side of the map screen. See *Configure Menu on page 64* in this section.

POIs Nearby

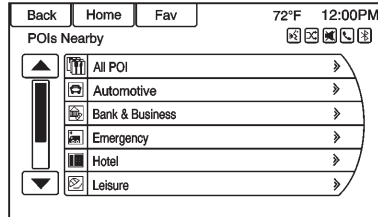

Press to display a search list of nearby POIs. Select the desired POI.

POIs Along Route

Press to display a search list of POIs that lie along or near the route to the destination. Select the desired POI.

Show POIs on Map

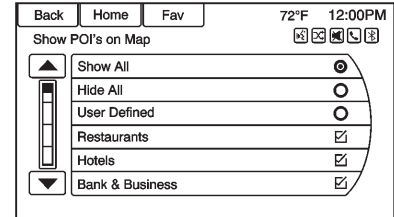

Press to customize which major POI categories are displayed on the map.

Switch Route Time/Destination

Press to customize the Arrival/Travel time and Waypoint/Destination information displayed in the main map screen.

Current Position Information

Press to display a split screen showing detailed information about the vehicle position. This feature can also be accessed by pressing the vehicle information tab on the lower center of the display. The location can be saved to the Address Book by pressing Save in the split screen.

Destination Information

Press to display a split map screen showing the next waypoint/destination. The location can be saved to the Address Book by pressing Save in the split screen.

Map Adjustments

The system lets you adjust the scale of view on the map. Also, as you drive, the map scrolls automatically based on the direction of travel.

Map Scales

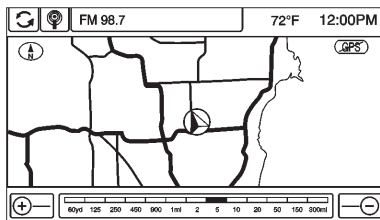

There are two methods to change the map scale:

- Turn the Menu knob clockwise or counterclockwise to zoom out or in.
- Press the Map Scale + or – button on the bottom corners of the map screen to change the zoom level.

The map scale bar times out if the zoom level is not changed within a few seconds.

The scale can be configured for English or metric units. To change from English to metric, see “Driver Information Center (DIC)” in the owner manual.

Scroll Features



- To scroll within the map, touch anywhere on the map screen and the scroll symbol displays.
- Tap the map to center at that location on the screen.
- Press and hold the screen in any direction outside the scroll symbol to scroll the map in that direction.
- Scroll speed increases when touching closer to the edge of the screen.

- Press NAV on the faceplate to exit map scrolling and return to the current vehicle location on the map.



Press the cycling arrows located at the top of the map screen to toggle from the normal top bar (Home and Fav) to the audio information bar.

Maps

This section includes basic information about the map database.

The data is stored in the internal flash memory that is used in the navigation system.

Detailed Areas

Road network attributes are contained in the map database for detailed areas. Attributes include information such as street names, street addresses, and turn restrictions. A detailed area includes all major highways, service roads, and residential roads. The detailed areas include points of interest (POIs) such as restaurants, airports, banks, hospitals, police stations, gas stations, tourist attractions, and historical monuments. The map database may not include data for newly constructed areas or map database corrections. The navigation system provides full route guidance in the detailed map areas.

Navigation Symbols

Following are the most common symbols that appear on a map screen.



The vehicle symbol indicates the current position and heading direction of the vehicle on the map.

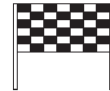

The destination symbol marks the final destination after a route has been planned.

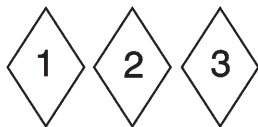

The waypoint symbol marks one or more set waypoints.

A waypoint is a stopover destination point added to the planned route.

The estimated time and distance to the destination are displayed.

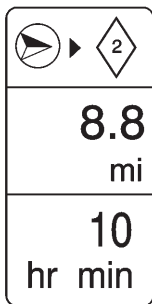

If waypoints have been added to the current route, each waypoint destination displays estimated time and distance.



This symbol indicates that the map view is North up: North up displays North at the top of the map screen regardless of the direction the vehicle is traveling.

Select this screen symbol to change the view to Heading up or 3D.



This symbol indicates that the map view is Heading up.

Heading up view displays the direction the vehicle is traveling at the top of the map screen. The shaded triangle indicates North.

Press this screen symbol to change to 3D mode.

The 3D symbol is the same as the Heading up symbol, but the map is in 3D.



The No GPS symbol appears when there is no Global Positioning System (GPS) satellite signal.

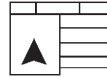

This symbol at the bottom of a map screen changes the current map mode screen.



This symbol on the right of the map screen displays the speed limit while on a route. The speed limit may not be accurate due to changes from the Department of Transportation, the local municipalities, or older map data. Always follow the posted speed limit on the road.

Driving on a Route

Urgent Maneuver Alert

The system will give an indication that the next maneuver is close.

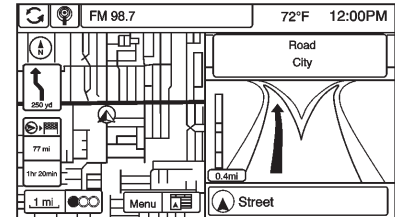

Driving on a Highway

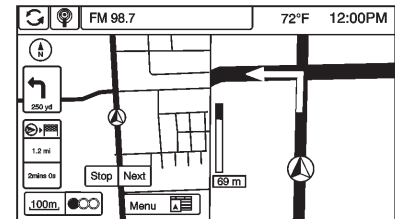

Driving on a Residential Road

Destination

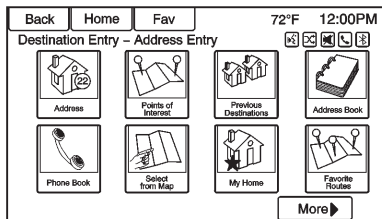

If route guidance is not active, press the Destination Entry screen button on the Home Page to access the Destination Entry screen. Several options can be selected to plan a route by entering destinations. Some destination entry items such as Previous Destinations, Address Book, and My Home may be grayed out if no destination was previously entered or saved.

Alpha-Numeric Keyboard

Letters of the alphabet, symbols, punctuation, and numbers, when available, display on the navigation screen as alpha/numeric keyboards. The alpha keyboard displays when data needs to be entered.

QWERTY or ABCDEF: Press to toggle between QWERTY or ABCDEF keyboard character layouts.

Symbols: Use to select symbols.

Space: Use to enter a space between characters or the words of a name.

Delete: Press to delete an incorrect character that has been selected.

Address Entry



Press the Address screen button to display the Enter Address screen. Set a route by entering the state name, city name, street name, house number, and intersection.

If no state or province has been entered previously, the city and state fields are not available. Press the screen button at the right of the city name to select a state or province.

If the state or province was previously set and is displayed, press the screen button at the right of the city name to change the selected state or province.

To make name selection easier, the system highlights only characters that are available after the previously entered one.

State: Enter a state name.

City: Enter a city name.

Street: Enter a street name.

House No.: Enter a valid address number.

Intersection: Enter a street name that intersects with the selected street.

Entering the city name first:

1. Enter the city name.
2. Enter the street name. Use the Delete screen button to delete an incorrectly entered character.

A list displays if six or fewer names are available. If there are more than six, there is a match counter with a number of available streets. Press the List screen button to view the list and select the street.

3. Enter the house number.
4. Press the Done screen button at any time and the system tries to resolve a destination based on the entered information, then displays it on the Destination Confirmation screen.

5. Press the Start Guidance screen button and the route calculates.

Entering a Destination in Other Countries

To change the destination address from the United States to another country, the country will need to change in the navigation system.

To change country address:

1. Press the Destination screen button on the Home Page.
2. Press the Address Entry screen button to display the Address Entry screen.

- Go to the State/Province line option and select. The State/Province entry screen displays. Select the Country line option. The available Country List displays.
- Select the desired country. For example, select Canada as a default country.
- Enter State/Province. For example, enter Ontario and confirm the selection.

The destination in other countries can also be changed using voice recognition. See *Voice Recognition* on page 72.

Points of Interest (POI)

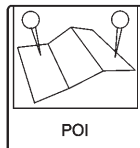

Press the Points of Interest screen button on the Destination Entry page. Several options can be selected to plan a route.

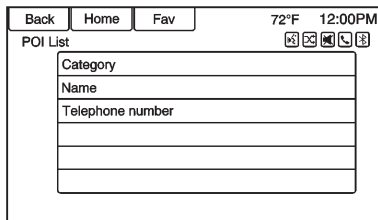
The screenshot shows a mobile interface with a top bar containing "Back", "Home", and "Fav" buttons, and the status "72°F 12:00PM". Below the bar is a "POI List" section with a list of input fields: "Category", "Name", and "Telephone number". There are also several small icons to the right of the "POI List" header.

The POI entry list allows selection of a destination search by category, name, or number.

Entering by POI name:

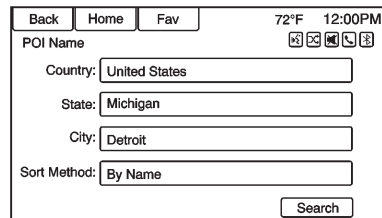
The screenshot shows a mobile interface with a top bar containing "Back", "Home", and "Fav" buttons, and the status "72°F 12:00PM". Below the bar is a "POI Name" section with a list of input fields: "Country: United States", "State: Michigan", "City: Detroit", and "Sort Method: By Name". There is also a "Search" button at the bottom right.

- Select Search by Name.
- Make sure the correct country, state, city are present, then select Search.
- Enter the POI name.
- Select a few of the characters or spell the name in full, by using the alpha keyboard.
- Press the List screen button, or if the list has six or fewer items, a list of POIs will immediately display.
- Press the desired POI.

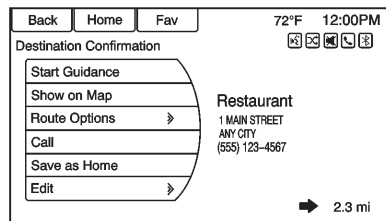

- Press the Start Guidance screen button and the route calculates.

Previous Destinations



Select a destination from the Previous Destination List. Up to 15 points that have been previously entered can be recalled. If the list is full, the oldest destinations are automatically deleted once the newest destinations are added.

Address Book

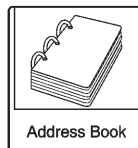

If no destination is saved to the address book, save a destination:

- Press Destination on the Home Page.
- Enter an address using any of the destination methods (Address Entry, POI Entry, etc.).
- On the Destination Confirmation screen, select Save.
- The system displays the options Name, Number, Icon, and Done. Press Done to save the destination.

- To customize the address book entry, select Name, Number, or Icon.

If a destination is already saved to the address book, press Destination Entry on the Home Page to display the Address Book screen button.

Choose a destination by selecting an address that has been stored in the address book.

- Press the Address Book screen button. A list displays the address book entries.
- Select the destination from the list.
- Press the Start Guidance screen button and the route calculates.

To edit Address Book entries:

- Select an item from the address book.
- On the Destination Confirmation screen, select Edit.

- The system displays the options Name, Number, Icon, and Delete. Press Delete to delete the destination from the address book.
- To customize the address book entry, select Name, Number, or Icon.

Latitude/Longitude Coordinates



Choose a destination based on latitudinal and longitudinal coordinates.

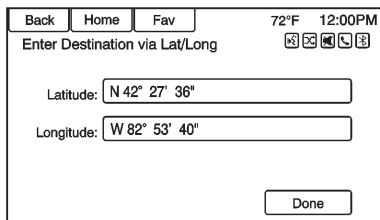

To enter the location as coordinates, latitude and longitude:

- Press Destination on the Home Page. Press the Latitude and Longitude screen button to display the screen above.
- Select Latitude or Longitude to change. Enter the coordinates in degrees, minutes, and seconds. Then press Back to save and exit.
- Press the Search screen button if the information is correct.
- Press the Start Guidance screen button. The route calculates.

Favorite Routes

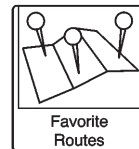

Adding a Favorite Route:

- Press the Home Page Destination Entry button to display the Favorite Routes screen button.
- Press the Favorite Routes screen button to display Add Favorite Route.
- Select Add Favorite Route and enter a favorite route name.
- Press OK and the display returns to the favorite routes list.
- Select the favorite route and add a waypoint using any of the destination methods, such as address entry, POI entry, etc.

Selecting a Favorite Route:

1. Press the Home Page Destination Entry button to display the Favorite Routes screen button.
2. Press the Favorite Routes screen button to display a list of available favorite routes.
3. Scroll and select a favorite route.
4. Press the Start Guidance screen button. The route calculates.

Deleting a favorite route:

1. Press the Home Page Destination Entry button to display the Favorite Routes screen button. Press this button to display the list of available favorite routes.
2. Scroll and select the route to be deleted.
3. Press Edit.
4. Press Delete Favorite Route.

Changing the route name:

1. Press the Home Page Destination Entry button to display the Favorite Routes screen button. Press this button to display the list of available favorite routes.
2. Press the Edit screen button.
3. Select Edit Name.
4. Using the keypad, enter the name.
5. Press the Done screen button. The new name will be in the Favorite Routes Menu.

My Home



If no home destination is entered, save a destination by pressing the Home Page Destination Entry button. Enter a destination using

any of the destination entry methods (Address Entry, POI Entry, etc.). Select Save as Home from the Destination Confirmation screen.

If a destination is already saved as home, press the Home Page Destination Entry button to display the My Home screen button. Press this button to start route guidance.

Select from Map

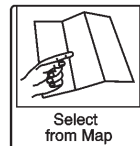

- Press the Home Page Destination Entry button to display the Select from Map screen button. Press this button to display the map screen with a scroll symbol centered on the map.

- Press the Zoom in/out button on the screen and press the map to locate the destination to select. Press and hold a finger on the map to activate fast scrolling.
- Press the Go button on the bottom of the screen to display the Destination Confirmation screen.
- Press the Start Guidance screen button. The route calculates.

Destination Confirmation

Multiple options are available on the Destination Confirmation screen:

Start Guidance: Press to start a route calculation to the displayed destination.

Show on Map: Press to switch to the map view with the displayed destination centered on the map.

Route Options: Press to change route options. See “Route Options” following.

Call: Press to initiate a phone call to the displayed phone number, if phone capability is available.

Save as Home: Press to save the displayed destination as your home destination. The home destination will be stored at the top of the list of destinations in the address book.

Save/Edit: Press to save the displayed destination into the address book. If the displayed destination is already stored in the address book, Edit will show as the menu item.

Route Options

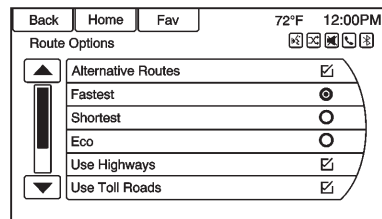

Press to display various route options.

Alternative Routes: If enabled, the system will provide an additional screen after Start Guidance has been selected. Select Fastest, Shortest, or Eco calculated routes before selecting GO.

Fastest: This calculates for the quickest route.

Shortest: This calculates for the shortest route.

Eco: This calculates for the most fuel efficient route based on speed and distance.

Under the Route Options menu, there are route preferences that by default are all enabled. A checkmark placed next to each preference indicates this. All of these preferences are used when calculating the route. If any of these preferences are unselected, the route will be calculated without including these preferences.

Use Highways: Deselect to avoid major roads.

Use Toll Roads: Deselect to avoid toll roads.

Use Ferries: Deselect to avoid ferries.

Use Tunnels: Deselect to avoid tunnels.

Use Time Restricted: Deselect to avoid time restricted roads.

Use Car Train: Deselect to avoid car trains.

Menu with Route Guidance Active

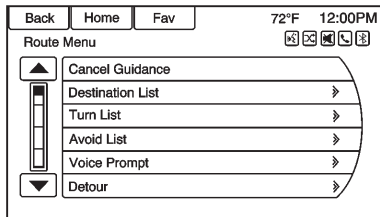

Several functions can be performed after a destination has been entered. Press the Home Page Destination Entry screen button to access the Destination Menu screen.

Cancel Guidance

Press Cancel Guidance to cancel the current route.

Destination List

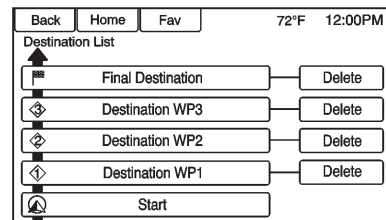

Select Destination List to view options for organizing waypoints.

Turn List

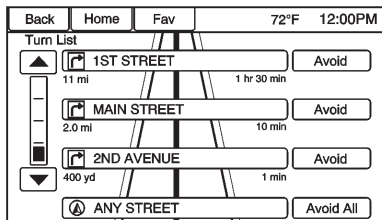

Select Turn List to view a list of maneuvers for the entire route. Press the Avoid screen button next to one of the turn maneuvers to avoid a segment of roads. A maximum of eight avoided segments are allowed.

Avoid List

Select Avoid List to display a list of avoided road segments with the option to remove the avoided items from the list.

Detour

Press Detour to display the route detour options. Select to detour the whole route or by a specific distance.

Route Options

This feature can be accessed from the Destination Confirmation Menu and Destination Menu with Route Guidance Active. See “Destination Confirmation” for more information.

Voice Prompt

Select Voice Prompt to view options to disable or manage navigation voice prompts and traffic alert prompts.

Waypoints

Up to three waypoints can be added to the current route. The waypoints can be sorted (moved) or deleted.

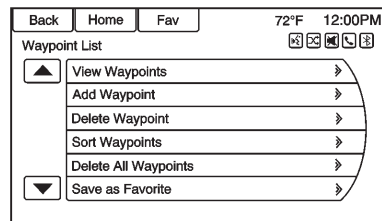

To add a waypoint:

1. From the Destination List menu, press Add Waypoint.
2. Enter the waypoint by any of the add destination methods. The system calculates and highlights the route and the route can be started.
3. To add more waypoints, press Add Waypoint to add the waypoint in the order desired on the route.

To delete a waypoint:

1. From the Destination menu, press Destination List.
2. Press Delete Waypoints.

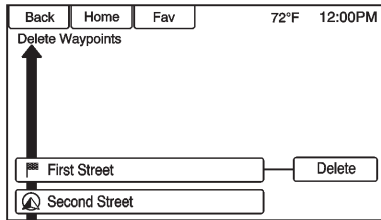

3. Select the waypoint to be deleted. Press the Delete screen button.

The Sort Waypoint feature allows reorganization of the destination list.

To sort a waypoint:

1. From the Destination menu, press Destination List.
2. Press Sort Waypoints.

3. Select the waypoint to move.
4. Select the location to move the waypoint to.

Instead of deleting individual waypoints, select Delete All Waypoints to delete all waypoints at the same time.

To save a destination list as a favorite route, select Save as Favorite Route.

OnStar® Destination Download

The destination download lets an OnStar® subscriber ask an OnStar Advisor to download a destination to the navigation system. OnStar will send address information and location coordinates of the destination into the navigation system.

Using Destination Download

If the navigation radio screen is turned off before a download, the system automatically turns the screen on and displays a download confirmation message. The radio remains on after the download.

The navigation system displays “Please wait” as the address is searched within the map database.

If the address is not found within the map database, the system may use latitude and longitude coordinates to locate the destination.

If the system is unable to locate the address, the Destination Not Found screen displays.

Route Guidance Not Active

If an OnStar destination is downloaded while route guidance is not active, the navigation system displays a pop-up screen with the following screen functions:

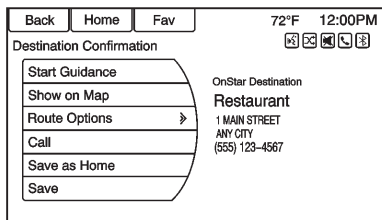

Start Guidance: Press to start route calculation to the destination(s) received.

Show on Map: Press to display the Map Screen.

Call: Press to initiate a call with Bluetooth Phone (if available) or OnStar Hands-Free Calling.

Save as Home: Press to set an address as a home destination.

Save: Press to save the downloaded destination to the address book.

Route Guidance Active

If an OnStar destination is downloaded while route guidance is already active, the system displays a pop-up screen with the following screen function:

- Press Start Guidance; the navigation system adds the downloaded destination before the next waypoint of the existing route (closest to the current vehicle position).
- All other buttons on the pop-up screen operate as described under "Route Guidance Not Active."

Previous Destinations

Previously downloaded OnStar destinations are saved under Previous Destinations in the navigation system, where they can be accessed or saved to the Address Book.

Configure Menu

The Configuration Menu is used to adjust features and preferences, such as Sound, Radio, Nav (Navigation), Display, or Time Settings.

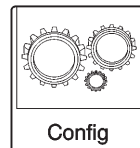

1. Press the Config screen button on the Home Page.

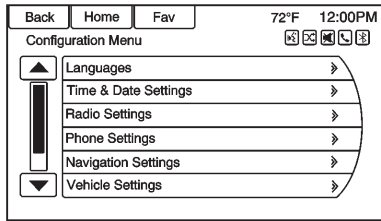

- Touch-tap the scroll bar until the desired option displays. Select the desired settings to change. See the owner manual for information on adjusting most vehicle settings. See “Navigation Settings” and “Navigation Settings Button” in this section.

Languages

Press the Config button on the Home Page or the CONFIG button on the faceplate to enter the menu options. Turn the Menu knob or touch-tap the scroll bar to scroll through the available options. Press the Menu knob or press Languages to display the languages. Select the desired language.

Time and Date Settings

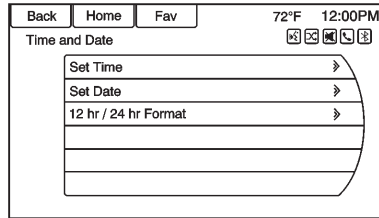

From the Time and Date Settings screen button, press to display the Time and Date Settings menu.

Set Time: Press the + or – to increase or decrease the Hours and Minutes displayed on the clock.

Set Date: Press the + and – to increase or decrease the day.

Set Time Format: Press the 12 Hour screen button for standard time; press the 24 Hour screen button for military time.

Press the Back screen button to save the adjustments.

Radio Settings

Press the Config button on the Home Page or the CONFIG button on the faceplate to enter the menu options. Turn the Menu knob or touch-tap the scroll bar to scroll through the available options. Press the Menu knob or press Radio Settings to display the radio settings menu. Press this feature to make changes for radio information displayed, preset pages, Auto Volume Control, and XM Categories Restore. See *Satellite Radio on page 17*, for more information about XM Categories.

The Radio Settings are:

Auto Volume: Select OFF, Low, Medium, or High sensitivity to automatically adjust the volume to minimize the effects of unwanted background noise that can result from changing road surfaces, driving speeds, or open windows.

This feature works best at lower volume settings where background noise is typically louder than the sound system volume.

Gracenote Options: Press to enable/disable Normalization used to improve voice recognition and media groupings. See *CD Player* on page 37, *USB* on page 39, *Auxiliary Devices* on page 45, and *Bluetooth Audio* on page 46.

XM Channel Graphics: Press to enable/disable the XM Audio page background on the XM Channel display.

Startup Volume: Press to set the maximum volume level for startup that will be used even if a higher volume had been set when the radio was turned off.

Number of Favorite Pages: Press to select the number of FAV pages to be displayed.

XM Categories: Press to customize which available XM Categories are used and displayed.

Software Version Information: Press to display information about the system and update software if available.

Phone Settings

See *Bluetooth* on page 79 in the "Phone" section for more information on phone settings.

Navigation Settings

Press the Config button on the Home Page to enter the setup menu. Turn the Menu knob or touch-tap the scroll bar until the Navigation Settings option displays. Select this feature to make changes to Voice Prompt, Traffic Settings, Guidance Alert, Bread Crumbs, and Delete Saved Destinations.

Navigation Settings Button

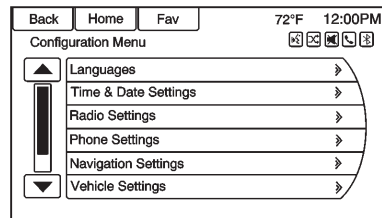

Various navigation system settings are available through the Configuration Menu. Some options are only available after a route is planned.

Press Navigation Settings to access the navigation system settings.

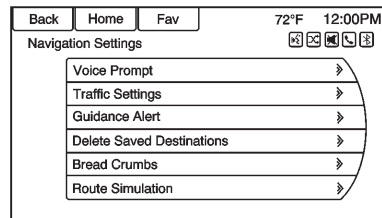

Voice Prompt

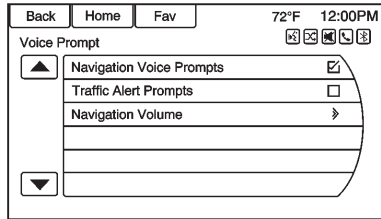

The Voice Prompt Menu allows changes to the voice prompt features.

Navigation Voice Prompts: Select the On or Off button to turn the voice instructions on or off while traveling on a planned route.

Traffic Alert Prompts: Select the On or Off button to turn the traffic voice prompt on or off while traveling on a planned route.

Navigation Voice: Select Navigation Voice Volume to change the volume of the navigation prompts.

Traffic Settings

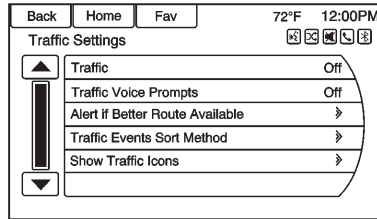

Press to display the Traffic Settings menu.

Traffic Events (On/Off): Press to enable or disable the traffic feature.

Traffic Alert Prompts (On/Off): Press to enable or disable the traffic voice prompts.

Alert if Better Route Available: Press to prompt an alert if a better route is available.

Sort Method: Press to display a submenu of sort options.

- **Sort by Distance:** Press to display traffic events in order of distance with the closest event shown first.

- **Sort by Name:** Press to display traffic events in alphabetical order.

Show Traffic Events on Map: Press to display traffic icons on the map.

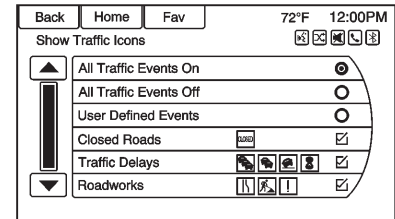

- **All Traffic Events On:** Press to enable display of all traffic icons on the map.
- **All Traffic Events Off:** Press to disable display of all traffic icons on the map.
- **User Defined Events:** Press to define the individual types of icons that are displayed for traffic flow and traffic conditions.

68 Infotainment System

Traffic Flow

The traffic flow status will display in green, yellow, or red lines beside the road.

- Red indicates significantly impaired traffic flow with average speed less than 40 km/h (25 mph).
- Yellow indicates slightly impaired traffic flow with average speed between 40 and 73 km/h (25 and 45 mph).
- Green indicates normal traffic flow with average speed above 73 km/h (45 mph).

Closed Roads, Traffic Delays, Roadwork, Incidents, and Advisories

Select the traffic event group for display on the map screen. Some events may cover more than one traffic condition. See the following traffic conditions.

Traffic Conditions

The following traffic condition icons may display:



Stopped Traffic



Accident



Lane Narrows



Traffic Jam



Road Closed



**Road Work,
Construction**



Alert



Road Visibility



Road Condition



Other

Delete Saved Destinations

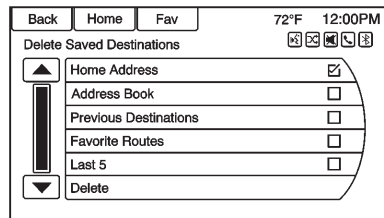

Press to delete all saved destinations. A Delete Saved Destinations submenu displays. Select the desired options for deletion and press delete at the bottom to continue. A confirmation screen displays requesting to delete or cancel.

Guidance Alerts

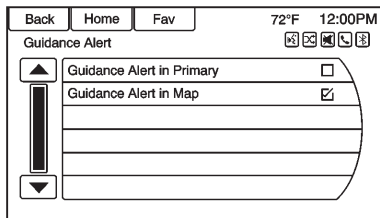

Press to enable the guidance alert pop-up to be viewed on the map or on the main screens such as audio, weather, phone, etc. A checkmark appears to indicate the guidance alert mode is on.

Vehicle Settings

See “Vehicle Personalization” in the owner manual.

Display Settings

Press the Config button on the Home Page or the CONFIG button on the faceplate, then select Display Settings from the list.

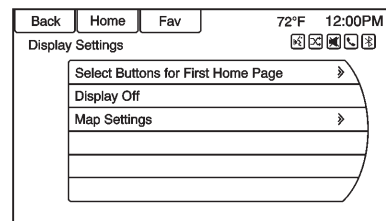

The following options may display:

Select Buttons for First Home Page

Page: Press to customize the first page of the Home Page.

Display Off: Press to turn off the display. The display will return when any radio buttons are pressed or the screen is touched (if equipped).

Map Settings: Press to enter the submenu to change Automatic Zoom, enable Speed Limit display on map, and change Map Display settings.

Map Display: Press to change the screen background.

- The Automatic setting adjusts the screen background automatically depending on the exterior lighting conditions.
- The Day setting brightens the map background.
- The Night setting darkens the map background.

To change the overall brightness setting for the display, use the vehicle interior lighting instrument panel illumination control.

Global Positioning System (GPS)

The position of the vehicle is determined by using satellite signals, various vehicle signals, and map data.

At times, other interference such as the satellite condition, road configuration, condition of the vehicle, and/or other circumstances

can affect the navigation system's ability to determine the accurate position of the vehicle.

The GPS shows the current position of the vehicle using signals sent by the GPS Satellites. When the vehicle is not receiving signals from the satellites, a symbol appears on the map screen. See *Navigation Symbols on page 51*.

This system might not be available or interference can occur if any of the following are true:

- Signals are obstructed by tall buildings, trees, large trucks, or a tunnel.
- Satellites are being repaired or improved.

For more information if the GPS is not functioning properly, see *Problems with Route Guidance on page 71* and *If the System Needs Service on page 72*.

Vehicle Positioning

At times, the position of the vehicle on the map could be inaccurate due to one or more of the following reasons:

- The road system has changed.
- The vehicle is driving on slippery road surfaces such as sand, gravel, or snow.
- The vehicle is traveling on winding roads or long straight roads.
- The vehicle is approaching a tall building or a large vehicle.
- The surface streets run parallel to a freeway.
- The vehicle has been transferred by a vehicle carrier or a ferry.
- The current position calibration is set incorrectly.
- The vehicle is traveling at high speed.

- The vehicle changes directions more than once, or the vehicle is turning on a turn table in a parking lot.
- The vehicle is entering and/or exiting a parking lot, garage, or a lot with a roof.
- The GPS signal is not received.
- A roof carrier is installed on the vehicle.
- Tire chains have been installed.
- The tires are replaced or worn.
- The tire pressure for the tires is incorrect.
- This is the first navigation use after the map data is updated.
- The 12-volt battery is disconnected for several days.
- The vehicle is driving in heavy traffic where driving is at low speeds, and the vehicle is stopped and started repeatedly.

Problems with Route Guidance

Inappropriate route guidance can occur under one or more of the following conditions:

- The turn was not made on the road indicated.
- Route guidance might not be available when using automatic rerouting for the next right or left turn.
- The route might not be changed when using automatic rerouting.
- There is no route guidance when turning at an intersection.
- Plural names of places might be announced occasionally.
- It could take a long time to operate automatic rerouting during high-speed driving.

- Automatic rerouting might display a route returning to the set waypoint if heading for a destination without passing through a set waypoint.
- The route prohibits the entry of a vehicle due to a regulation by time or season or any other regulation which may be given.
- Some routes might not be searched.
- The route to the destination might not be shown if there are new roads, if roads have recently changed, or if certain roads are not listed in the map data. See *Maps on page 51*.

To recalibrate the vehicle's position on the map, park with the vehicle running for two to five minutes, until the vehicle position updates. Make sure the vehicle is parked in a location that is safe and has a clear view of the sky and away from large obstruction.

If the System Needs Service

If the navigation system needs service and the steps listed here have been followed but there are still problems, see your dealer for assistance.

Map Data Updates

The map data in the vehicle is the most up-to-date information available when the vehicle was produced. The map data is updated periodically, provided that the map information has changed.

For questions about the operation of the navigation system or the update process, contact the GM Nav Disc Center toll-free phone number, 1-877-NAV-DISC (1-877-628-3472) or go to the center's website, www.gmnavdisc.com. If updates are

needed, call the GM Nav Disc Center or order a new Map Update online. To order map data, have the vehicle's Vehicle Identification Number (VIN) available. See "Vehicle Identification Number (VIN)" in the owner manual.

After receiving the updated map data, see *Maps on page 51*.

Database Coverage Explanations



Coverage areas vary with respect to the level of map detail available for any given area. Some areas feature greater levels of detail than others. If this happens, it does not mean there is a problem with the system. As the map data is updated, more detail can become available for areas that previously had limited detail. See *Map Data Updates on page 72*.

Voice Recognition

Voice recognition allows for hands-free operation of the infotainment system features.

Voice recognition can be used when the radio is on or when Retained Accessory Power (RAP) is active. See "Retained Accessory Power (RAP)" in the owner manual. The system maintains a minimum volume level.



Using Voice Recognition

1. Press  /  on the steering wheel. The audio system mutes. A voice prompt states, "Please say a command." Wait until the tone is heard before speaking.



If there is no tone, make sure that the volume is turned up.

While voice recognition is active, the system displays a  symbol in the top right of the screen.

- Clearly speak one of the commands listed later in this section.

Press  /  twice on the steering wheel to skip the voice prompt messages.

Canceling Voice Recognition

- Press and release  /  on the steering wheel control to cancel a command, if the system response does not match the voice command, or say “Goodbye” or “Cancel.”
- The system replies, “Goodbye.”

Helpful Hints for Speaking Commands

- When multiple commands are available, choose the command that works best for you.
- Words in parentheses are optional. For example, for the command “Tune FM

(frequency),” saying “Tune FM 87.7” or “Tune FM” are both valid commands.

- When the command is recognized, the system will either perform the function or ask to confirm the choice.
- When the system does not recognize the command, the system says “pardon.”
- If experiencing difficulty with the system recognizing a command, confirm that the command is correct. Try saying the command clearly or wait for a brief moment after the tone.
- Background noise such as a climate control fan positioned on high, open windows, and very loud outside noises, even if the windows are closed, can cause voice commands to be misunderstood.
- The system is able to recognize commands in different languages, such as English,

Canadian French, and Spanish. The system only recognizes commands based on the language selected.

- To increase or decrease the voice volume during a voice recognition session, turn the volume knob of the radio, or press the volume steering wheel control. If the volume is adjusted during a voice recognition session, a Volume bar appears on the screen showing the voice volume level as it is being adjusted. This also changes the volume of the guidance prompts.
- When using navigation commands, take the time to become familiar with the address. Long delays when giving the address can result in the system not recognizing the address or routing to different location than intended.

- When providing the house number portion of the address, the system recognizes both digit format and numerical text. An example would be to say, “3-0-0-0-1” or “Thirty Thousand One.”
- If the system provides destination in another country on several attempts, say the “Change Country” command and say the country of interest. The country default is the United States. To enter a destination in Canada or Mexico, the country will first have to be changed in the system.

Voice Recognition Help

To enter the help playback session, clearly speak one of the help commands.

Help: The system plays back more specific help commands such as Radio Settings for the user to choose from.

Radio: Use this command to learn about how to select a band (AM, FM, or XM), and how to change radio stations by speaking frequency numbers.

Phone: Use this command to learn about how to dial, pair a device, or delete a device.

My Media: Use this command to learn how to play specific tracks, artists, albums, devices connected to the USB port, or to change sources.

Settings: Use this command to learn about how to turn Verbose on or off, or set the language.

Voice Recognition Commands

The following list shows the voice commands available for the infotainment system with a brief description of each. The commands are listed with the optional words in parentheses. To use the voice commands, see the previous instructions.

Radio Commands

Tune AM, Tune FM, Tune XM, Tune Pandora, Tune Stitcher: Instructs the system to go to the specific band and the last station.

Tune AM (frequency), Tune FM (frequency), Tune XM (station number), or Tune XM (station name): Instructs the system to go to the specific station.

Thumbs Up: Instructs the system to give the current song or station a thumbs up in Pandora or Stitcher.

Thumbs Down: Instructs the system to give the current song or station a thumbs down in Pandora or Stitcher.

Phone Commands

Dial or Call (phone number or contact): Instructs the system to start a phone call. For example, say "Dial 1 248 123 4567." To call a phone book contact, say "Dial" or "Call," say the name and location, and then say "Dial." For example, say "Call John at Home" or "Call John at Work." If a number is not recognized, the first number in the list will be called.

Pair or Connect: Instructs the system to begin pairing a device.

Digit Dial: Instructs the system to dial a phone number one digit at a time. After saying the digits, say "Dial."

Redial or Redial Last Number: Instructs the system to dial the last phone number called.

Select Device or Change Phone: Instructs the system to switch to a different paired device. The device must be selected from the screen or using Menu knob.

Delete Device: Instructs the system to delete a paired device.

My Media Commands

CD, AUX, USB, or Bluetooth

Audio: Instructs the system to change the source.

Play CD: Instructs the system to play a CD. For example, say "Play CD."

The following commands only apply to USB, iPod, iPhone sources. They are supported after the device has been indexed.

Play Artist (artist name): Instructs the system to play songs by a specific artist. For example, say "Play Artist <artist name>."

Play Album (album title): Instructs the system to play a specific album.

Play Song (song title): Instructs the system to play a specific song.

Play Genre (genre name): Instructs the system to play songs of a particular genre.

Search Artist (artist name): Instructs the system to show a list of all songs by a specific artist. For example, say "Search Artist <artist name>."

Search Composer (composer name): Instructs the system to show a list of all songs by a specific composer. For example, say "Search Composer <composer name>."

Search Album (album name): Instructs the system to show a list of all songs by a specific album. For example, say "Search Album <album name>."

Search Genre (genre name): Instructs the system to show a list of all songs for a specific genre. For example, say "Search Genre <genre name>."

Search Folder (folder name): Instructs the system to show a list of all songs in a specific folder. For example, say "Search folder <folder name>."

Search Playlist (playlist name):

Instructs the system to show a list of all songs in a specific playlist. For example, say "Search playlist <playlist name>."

Search Audiobook (audiobook name):

Instructs the system to show a list of all tracks in a specific audiobook. For example, say "Search audiobook <audiobook name>."

Search Playlist (playlist name):

Instructs the system to show a list of all songs in a specific playlist. For example, say "Search playlist <playlist name>."

Search Podcast (podcast name):

Instructs the system to show a list of all tracks in a specific podcast. For example, say "Search podcast <podcast name>."

More Like This: Instructs the system to create a playlist of tracks similar to the current track playing.

Settings Commands**Verbose (set) on (mode), Verbose (set) off (mode):**

Instructs the system to turn voice prompts on or off. When off, this feature turns off voice prompts.

Language (language): Instructs the system to set the language.

List Devices: Instructs the system to give a list of devices to use.

Other Commands

Goodbye: Instructs the system to end a phone call or voice recognition.

Cancel: Instructs the system to cancel an action.

Go Back, Back, Previous:

Instructs the system to go back to a prior menu.

Main Menu: Instructs the system to go to the main menu.

Yes, Yep, Yup, Ya, Sure, Right, Correct, OK, Positive, You Got it, Probably, You Bet: These can be used to say "Yes."



No, Nope, Na, No way, Wrong, Incorrect, Negative, Not really, No I said, No I Did Not, No I Do Not: These can be used to say "No."

Next Page, Page Down: Instructs the system to scroll forward one page in a list.

Previous Page, Page Up: Instructs the system to scroll back one page in a list.

Navigation Commands (If Equipped)

To activate the navigation voice recognition:

1. Press  /  on the steering wheel. The audio system mutes. A voice prompt says, "Please say a command." Wait until the tone is heard before speaking.

If there is no tone, make sure the volume is turned up.

While voice recognition is active, the system displays a symbol in the top right of the screen.

2. Clearly speak the command "Navigation."
3. Clearly speak one of the commands in this section.

The following commands only apply once the Navigation command is given.

Change Country: Changes the country origin to input a destination from that region. The system will accept United States, Canada, or Mexico.

Address or Destination: Allows an address to be stated as a one-shot method. The system will recognize the address if stated all at once or say a city center. An example is to say, "200 Renaissance Street, Detroit, Michigan" or "Detroit, Michigan."

Directed Address: Allows an address to be stated one step at a time. The format will be State, City, Street, then House Number.

Intersection: Allows an Intersection to be stated as the destination. The format will be State, City, Street, then Junction.

Home: Instructs the system to start guidance to address saved as My Home.

Contact: When a phone is paired to the system, which contains Address Information stored for contacts, the address associated with that contact can become a route. If the system cannot resolve the address, an error displays.

Points of Interest or POI: Allows a Point of Interest to be stated as a destination. Become familiar with the POI categories and sub-categories in the system by pressing Destination from the Home Page or DEST from the faceplate, then selecting Point of Interest. POI commands for Along Route and Around Destination will be available if route guidance is active.

Add Waypoint: Allows addition of individual waypoints or the destination. The system will ask for the choice of entry method to continue. An example is to say, "POI Along Route" or "Intersection."

Delete Waypoint: When guidance is active, this command allows the deletion of individual waypoints or the destination. If guidance is not active, the system will indicate the destination list is empty.



Where Am I?, My Location, or Current Position: Instructs the system to give the current position of the vehicle.

Help: The system plays back more specific help commands associated with Navigation or a Navigation sub-feature.



Entering a Destination in Other Countries

For the voice recognition to respond to a local address the corresponding country needs to be set in the navigation system.

The country can also be set using voice commands. However, the country will change back to the default country when the vehicle is keyed off.

1. Press  /  on the steering wheel.
2. Say "Navigation."
3. Say "Change Country."
4. Say the country name. For example, say "Canada."

OnStar Command (If Equipped)

To activate OnStar voice recognition, press  on the mirror or press  /  on the steering wheel and say "OnStar" after the beep. This will activate the OnStar voice control. See OnStar in the owner manual.

Help Commands

- Help
- Hands-Free Calling
- Turn-by-Turn Directions
- OnStar Info

After each list of help commands, the following are available:

- Go Back
- Repeat
- Cancel
- Help
- Goodbye

Hands-Free Calling

- Call
- Store
- Commands
 - Call
 - Store
 - My Number
 - Minutes

- Store Last Number
- Digit Dial
- Redial
- Dial
- Number Recall
- Directory
- Digit Store

Turn-by-Turn Directions

- Directory
- Plan Route
- Commands
 - Directory
 - Store Destination
 - Plan Route
 - Delete Destination
 - Mute Directions

OnStar Info

- Messages
- Minutes
- My Number
- Commands
 - Messages
 - Virtual Advisor
 - My Number
 - Minutes
 - Number Recall
 - Advisor Playback
- Virtual Advisor

Virtual Advisor

Choose this option to connect to a live Advisor.

Bluetooth Phone/ Devices

Bluetooth

Overview

For vehicles equipped with Bluetooth capability, the system can interact with many cell phones and devices, allowing:

- Placing and receiving hands-free calls.
- Sharing of the cell phone's address book or contact list with the vehicle. The phone book will only display when that phone is connected.
- Placing outgoing calls by voice recognition.



The system can be used while in ON/RUN, ACC/ACCESSORY, or Retained Accessory Power (RAP). The range of the Bluetooth system can be up to 9.1 m (30 ft). The radio can connect to most Bluetooth-enabled phones. Available features and functions may be dependent on the device.

Bluetooth Controls

Use the buttons on the infotainment system and the steering wheel to operate the Bluetooth system.

Steering Wheel Controls



 /  (Push to Talk): Press to answer incoming calls and start voice recognition.

 /  (Mute/End Call): Press to end a call, decline an incoming call, or cancel voice recognition.

+  - (Volume): Press + or - to increase or decrease the volume.

Infotainment System Controls

For information about how to navigate the menu system using the infotainment controls, see *Overview on page 3*.

 /  (Phone/Mute): Press to enter the Phone main menu. Press and hold to mute or unmute.

Voice Recognition



The voice recognition system uses commands to control the system and dial phone numbers.

When using voice recognition:

- The system may not recognize voice commands if there is too much background noise.
- A tone sounds to indicate that the system is ready for a voice command. Wait for the tone and then speak.
- Speak clearly in a calm and natural voice.

See *Voice Recognition on page 72*.

Audio System

Sound comes through the vehicle's front audio system speakers and overrides the audio system. Use the VOL/ or  /  knob during a call to change the volume level. The adjusted volume level remains in memory for later calls. The system maintains a minimum volume level.

See *Voice Recognition on page 72*.

Bluetooth Audio

See *Bluetooth Audio on page 46*.



Pairing with Infotainment Controls

A Bluetooth-enabled cell phone must be paired and then connected to the vehicle before it can be used. See your cell phone manufacturer's user guide for Bluetooth functions before pairing the cell phone. If a Bluetooth phone is not connected, calls will be made using OnStar Hands-Free Calling, if available. See "OnStar" in the owner manual.

Pairing Information

- A Bluetooth-enabled phone and an audio playback device can be paired to the system at the same time.
- Up to five devices can be paired to the Bluetooth system.
- The pairing process is disabled when the vehicle is moving.
- Pairing only needs to be completed once, unless the pairing information on the cell phone changes or the cell phone is deleted from the system.
- Only one paired cell phone can be connected to the Bluetooth system at a time.
- If multiple paired cell phones are within range of the system, the radio will connect to the first phone in the list or to the phone that was previously connected.

Pairing a Phone/Device

1. Press the CONFIG button or  / .
2. Select Phone Settings.
3. Select Pair Device (Phone). The radio displays "Please start Bluetooth search on your phone. Confirm or enter number:." If the device supports a four-digit Personal Identification Number (PIN), it will display. The PIN is used in Step 5.
4. Start the pairing process on the cell phone to be paired to the vehicle. See the cell phone manufacturer's user guide.
5. Locate and select the device named after the vehicle make and model in the list on the cell phone. Follow the instructions on the cell phone to enter the PIN provided in Step 4, or to confirm the six-digit code matches. The system recognizes the new connected phone after the pairing process is complete.

6. If the phone prompts to accept connection or allow phone book download, select always accept and allow. The phone book may not be available if not accepted. Some phones will put connection request or phonebook request in a pull down task bar at the top of the screen. Drag down the task bar and look for connection/phonebook request and accept.
7. Repeat to pair additional phones.

Listing All Paired and Connected Phones/Devices

1. Press the CONFIG button.
2. Select Phone Settings.
3. Select Device List.

Deleting a Paired Phone/Device

1. Press the CONFIG button.
2. Select Phone Settings.
3. Select Device List.

4. Select the phone to delete and follow the screen prompts.

Connecting to a Different Phone

To connect to a different phone, the new phone must be in the vehicle and available to be connected to the Bluetooth system before the process is started.



1. Press the CONFIG button.
2. Select Phone Settings.
3. Select Device List.
4. Select the new phone to connect to and follow the screen prompts.

Pairing with Voice Recognition

A Bluetooth-enabled cell phone must be paired and then connected to the vehicle before it can be used. See the cell phone manufacturer's user guide for Bluetooth functions before pairing the cell phone. If a Bluetooth phone is not connected, calls will be made using OnStar



Hands-Free Calling, if available. See "OnStar" in the owner manual for more information.

Pairing a Phone

1. Press  / . The system responds "Please Say a Command," followed by a tone.
2. Say "Pair." The system responds with "Please search for Bluetooth devices on your phone. Confirm or enter number."
3. Start the pairing process on the phone to be paired.
4. Locate and select the device named after the vehicle make and model in the list on the cell phone. Follow the instructions on the cell phone to enter the PIN provided in Step 3 or to confirm the six-digit code matches. The system responds "successfully paired."
5. Repeat Steps 1–4 to pair additional phones.



Listing All Paired and Connected Phones



The system can list all cell phones paired to it. If a paired cell phone is also connected to the vehicle, the system responds with "is connected" after that phone name.

1. Press  / . The system responds "Please Say a Command," followed by a tone.
2. Say "Device List."

Deleting a Paired Phone



If the phone name to delete is unknown, see "Listing All Paired and Connected Phones."

1. Press  / . The system responds "Please Say a Command," followed by a tone.
2. Say "Delete Device."
3. The system responds with: "To delete a device, please touch its name on the screen." Select the device to delete on the display and it will be removed.

To cancel this command, press  /  on the steering wheel control or press the BACK button on the radio faceplate.

Connecting to a Different Phone or Device

To connect to a different cell phone, the system looks for the next available cell phone. Depending on the cell phone to be connected, this command may need to be repeated.

1. Press  / . The system responds "Please Say a Command," followed by a tone.
2. Say "Change Phone."
 - To select a device, press the name on the display.
 - If another cell phone is not found, the original phone remains connected.

Making a Call Using Phone Book and Infotainment Controls

For cell phones that support the phone book feature, the Bluetooth system can use the contacts stored on the cell phone to make calls. See the cell phone manufacturer's user guide or contact the wireless provider to find out if this feature is supported.



When a cell phone supports the phone book feature, the Phone Book and Call Lists menus are automatically available.

The Phone Book menu allows access to the phone book stored in the cell phone to make a call.



The Call Lists menu allows access to the phone numbers from the Incoming Calls, Outgoing Calls, and Missed Calls menus on the cell phone to make a call.

The radio will display the first 1,000 contacts and the phone numbers for each contact including Home, Work, Mobile, and Other.

To make a call using the Phone Book menu:

1. Press  /  once on the radio or the Phone screen button.
2. Select Phone Book.
3. Select the letter group of the phone book entry to scroll through the list of names/numbers.
4. Select the name.
5. Select the number to call.



To make a call using the Call Lists menu:

1. Press  /  once on the radio or the Phone screen button.
2. Select Call Lists.
3. Select the Incoming Calls, Outgoing Calls, or Missed Calls list.

4. Select the name or number to call.

Making a Call Using the Infotainment Controls

To make a call:

1. Press  /  once on the radio or the Phone screen button.
2. Press Enter Number.
3. Enter the phone number.
4. Select OK to start dialing the number.
5. Select Call to place the call.

To make a call using voice recognition, see “Making a Call” under *Hands-Free Phone on page 86*.





Accepting or Declining a Call

When an incoming call is received, the infotainment system mutes and a ring tone is heard in the vehicle.

Using the Infotainment Controls

Turn the Menu knob to “Answer” or “Decline” and press the Menu knob or press Accept or Decline on the screen.

Using Steering Wheel Controls

Press  /  to answer or  /  to decline the call.

Call Waiting Using the Infotainment Controls







Call waiting must be supported on the Bluetooth phone and enabled by the wireless service carrier to work.

Switching Between Calls (Call Waiting Calls Only)

To switch between calls turn and press the Menu knob and select Switch Call or select Switch Call on the screen.

Call Waiting Using Steering Wheel Controls

Call waiting must be supported on the cell phone and enabled by the wireless service carrier.

- Press  /  to answer an incoming call when another call is active. The original call is placed on hold.
- Press  /  again to return to the original call.
- To decline answering the incoming call, press Decline on the screen or take no action.
- Press  /  to disconnect the current call and switch to the call on hold.

Conference Calling Using the Infotainment Controls

Conference calling and three-way calling must be supported on the Bluetooth phone and enabled by the wireless service carrier to work. This feature is only supported when the vehicle is not moving.

To start a conference while in a current call:

1. Turn and press the Menu knob and select Enter Number.
2. Enter the phone number and select OK.
3. After the call has been placed, turn the Menu knob and choose Merge Calls.
4. To add more callers to the conference call, repeat Steps 1–3. The number of callers that can be added is limited by your wireless service carrier.

Ending a Call

Using the Infotainment Controls

Turn and press the Menu knob and select Hang Up or press Hang Up on the screen.

Using Steering Wheel Controls

Press  / .

Muting a Call

During a call, all sounds from inside the vehicle can be muted so that the person on the other end of the call cannot hear them.

Using the Infotainment Controls



Turn and press the Menu knob and select Mute Call. Press again to cancel mute.

Transferring a Call



Audio can be transferred between the Bluetooth system and the cell phone.

The cell phone must be paired and connected with the Bluetooth system before a call can be transferred.

To Transfer Audio from the Bluetooth System to a Cell Phone

During a call with the audio in the vehicle, press the Transfer Call button on the screen or press and hold the  /  button on the steering wheel.

To Transfer Audio to the Bluetooth System from a Cell Phone

Use the audio transfer feature on the cell phone. See your cell phone manufacturer's user guide for more information. Press the Transfer call button on the screen or press and hold the  /  button on the steering wheel.

Dual Tone Multi-Frequency (DTMF) Tones



The in-vehicle Bluetooth system can send numbers during a call. This is used when calling a menu-driven phone system.

Using the Infotainment Controls

1. Turn and press the Menu knob and select Enter Number.
2. Enter the phone number, or select Enter Number on the screen and select digits, then press OK.

Hands-Free Phone

Using Bluetooth Voice Recognition

To use voice recognition, press the  /  button on the steering wheel. Use the commands below for the various voice features. For additional information, say “Help” while in a voice recognition menu.

Making a Call

Calls can be made using the following commands.



Dial or Call: These commands can be used interchangeably to dial a phone number.

Digit Dial: This command allows a phone number to be dialed by entering the digits one at a time.

Re-dial: This command dials the last number used on the cell phone.



Using the “Dial” or “Call” Command

To call a number:

1. Press  / . The system responds “Please Say a Command,” followed by a tone.
2. Say “Dial” or “Call.”
3. Say the entire number without pausing, followed by “Dial.”

Once connected, the person called will be heard through the audio speakers.



To call using a name tag:

1. Press  / . The system responds “Please Say a Command,” followed by a tone.
2. Say “Dial” or “Call” and then say the name tag. For example “Call John at Work.”

Once connected, the person called will be heard through the audio speakers.

Using the “Digit Dial” Command

This allows a phone number to be dialed by entering the digits one at a time.



1. Press  / . The system responds “Please Say a Command,” followed by a tone.
2. Say “Digit Dial.”

- Say each digit, one at a time, to dial. After each digit is entered, the system repeats back the digit it heard followed by a tone. After the last digit has been entered, say "Dial."

If an unwanted number is repeated back, say "Clear" to clear the last number.

Once connected, the person called will be heard through the audio speakers.

Using the "Re-dial" Command

- Press  / . The system responds "Please Say a Command," followed by a tone.

- After the tone, say "Re-dial." The system dials the last number called from the connected cell phone.

Once connected, the person called will be heard through the audio speakers.

Clearing the System

Unless information is deleted out of the vehicle Bluetooth system, it will be retained. This includes phone pairing information. For directions on how to delete this information, see "Deleting a Paired Phone/Device."

Trademarks and License Agreements

FCC Information

See "Radio Frequency Statement" in the owner manual for information regarding Part 15 of the Federal Communications Commission (FCC) rules and with Industry Canada Standards RSS-GEN/210/220/310.

Mexico:

"La operación de este equipo está sujeta a las siguientes dos condiciones: (1) es posible que este equipo o dispositivo no cause interferencia perjudicial y (2) este equipo o dispositivo debe aceptar cualquier interferencia, incluyendo la que pueda causar su operación no deseada."



"Made for iPod" and "Made for iPhone" mean that an electronic accessory has been designed to connect specifically to iPod or iPhone and has been certified by the developer to meet Apple performance standards.

iPod and iPhone are trademarks of Apple Computer, Inc., registered in the U.S. and other countries.



Fees and Taxes: Subscription fee, taxes, one time activation fee, and other fees may apply. Subscription fee is consumer only. All fees and

programming subject to change. Subscriptions subject to Customer Agreement available at www.siriusxm.com. SiriusXM[®] service only available in the 48 contiguous United States and Canada.

In Canada: Some deterioration of service may occur in extreme northern latitudes. This is beyond the control of SiriusXM[®] Satellite Radio.

Explicit Language Notice: Channels with frequent explicit language are indicated with an "XL" preceding the channel name. Channel blocking is available for SiriusXM Satellite Radio receivers by notifying SiriusXM:

- USA: 866-635-2349 or see www.siriusxm.com.
- Canada: 877-209-0079 or see www.xmradio.ca.

It is prohibited to copy, decompile, disassemble, reverse engineer, hack, manipulate, or otherwise make available any technology or software incorporated in receivers compatible with the SiriusXM Satellite Radio System or that support the SiriusXM website, the Online Service or any of its content. Furthermore, the AMBER voice compression software included in this product is protected by intellectual property rights including patent rights, copyrights, and trade secrets of Digital Voice Systems, Inc.

General Requirements:

1. A License Agreement from SiriusXM is required for any product that incorporates SiriusXM Technology and/or for use of any of the SiriusXM marks to be manufactured, distributed, or marketed in the SiriusXM Service Area.

- For products to be distributed, marketed, and/or sold in Canada, a separate agreement is required with Canadian Satellite Radio Inc. (operating as XM Canada).

Gracenote

Gracenote[®], Gracenote logo and logotype, and the "Powered by Gracenote" logo are either a registered trademark or a trademark of Gracenote, Inc. in the United States and/or other countries.

Bluetooth

The Bluetooth[®] word mark and logos are owned by the Bluetooth[®] SIG, Inc. and any use of such marks by General Motors is under license. Other trademarks and trade names are those of their respective owners.

Pandora (If Equipped)

Pandora is a registered trademark of Pandora Media, Inc., used under license.



Manufactured under license from Dolby Laboratories. Dolby and the double-D symbol are trademarks of Dolby Laboratories.

Map End User License Agreement (Optional Equipment Applies Where Equipped)

END USER TERMS

The Map Data ("Data") is provided for your personal, internal use only and not for resale. It is protected by copyright, and is subject to the following terms (this "End User License Agreement") and conditions which are agreed to by you, on the one hand, and NAVTEQ North

America, LLC ("NT") and its licensors (including their licensors and suppliers) on the other hand.

The Data for areas of Canada includes information taken with permission from Canadian authorities, including: © Her Majesty the Queen in Right of Canada, © Queen's Printer for Ontario, © Canada Post Corporation, GeoBase[®].

NT holds a nonexclusive license from the United States Postal Service[®] to publish and sell ZIP+4[®] information.

© United States Postal Service[®] 2012. Prices are not established, controlled, or approved by the United States Postal Service[®]. The following trademarks and registrations are owned by the USPS: United States Postal Service, USPS, and ZIP+4.

TERMS AND CONDITIONS

Personal Use Only: You agree to use this Data for the solely personal, noncommercial purposes for which you were licensed, and not for service bureau, timesharing or other similar purposes. Except as otherwise set forth herein, you agree not to otherwise reproduce, copy, modify, decompile, disassemble or reverse engineer any portion of this Data, and may not transfer or distribute it in any form, for any purpose, except to the extent permitted by mandatory laws. You may transfer the Data and all accompanying materials on a permanent basis if you retain no copies and the recipient agrees to the terms of this End User License Agreement. Multi-disc sets may only be transferred or sold as a complete set as provided to you and not as a subset thereof.

Restrictions

Except where you have been specifically licensed to do so by NT and without limiting the preceding paragraph, you may not (a) use this Data with any products, systems, or applications installed or otherwise connected to or in communication with vehicles capable of vehicle navigation, positioning, dispatch, real time route guidance, fleet management or similar applications; or (b) with, or in communication with, including without limitation, cellular phones, palmtop and handheld computers, pagers, and personal digital assistants or PDAs.

Warning

This Data may contain inaccurate or incomplete information due to the passage of time, changing circumstances, sources used, and the nature of collecting comprehensive geographic data, any of which may lead to incorrect results.

No Warranty

This Data is provided to you "as is," and you agree to use it at your own risk. NT and its licensors (and their licensors and suppliers) make no guarantees, representations, or warranties of any kind, express or implied, arising by law or otherwise, including but not limited to, content, quality, accuracy, completeness, effectiveness, reliability, fitness for a particular purpose, usefulness, use or results to be obtained from this Data, or that the Data or server will be uninterrupted or error free.

Disclaimer of Warranty

THE DATABASE IS PROVIDED ON AN "AS IS" AND "WITH ALL FAULTS BASIS" AND PANASONIC (AND THEIR LICENSORS AND SUPPLIERS) EXPRESSLY DISCLAIM ALL OTHER WARRANTIES, EXPRESS OR IMPLIED, INCLUDING BUT NOT LIMITED TO, THE IMPLIED WARRANTIES OF NON-INFRINGEMENT,

MERCHANTABILITY, SATISFACTORY QUALITY, ACCURACY, TITLE AND FITNESS FOR A PARTICULAR PURPOSE. NO ORAL OR WRITTEN ADVICE OR INFORMATION PROVIDED BY PANASONIC (OR ANY OF THEIR LICENSORS, AGENTS, EMPLOYEES, OR THIRD PARTY PROVIDERS) SHALL CREATE A WARRANTY, AND YOU ARE NOT ENTITLED TO RELY ON ANY SUCH ADVICE OR INFORMATION. THIS DISCLAIMER OF WARRANTIES IS AN ESSENTIAL CONDITION OF THIS AGREEMENT.

Disclaimer of Liability

NT AND ITS LICENSORS (INCLUDING THEIR LICENSORS AND SUPPLIERS) SHALL NOT BE LIABLE TO YOU IN RESPECT OF ANY CLAIM, DEMAND OR ACTION, IRRESPECTIVE OF THE NATURE OF THE CAUSE OF THE CLAIM, DEMAND OR ACTION

ALLEGING ANY LOSS, INJURY OR DAMAGES, DIRECT OR INDIRECT, WHICH MAY RESULT FROM THE USE OR POSSESSION OF THIS DATA; OR FOR ANY LOSS OF PROFIT, REVENUE, CONTRACTS OR SAVINGS, OR ANY OTHER DIRECT, INDIRECT, INCIDENTAL, SPECIAL OR CONSEQUENTIAL DAMAGES ARISING OUT OF YOUR USE OF OR INABILITY TO USE THIS DATA, ANY DEFECT IN THIS DATA, OR THE BREACH OF THESE TERMS OR CONDITIONS, WHETHER IN AN ACTION IN CONTRACT OR TORT OR BASED ON A WARRANTY, EVEN IF NT OR ITS LICENSORS HAVE BEEN ADVISED OF THE POSSIBILITY OF SUCH DAMAGES. Some States, Territories, and Countries do not allow certain liability exclusions or damages limitations, so that extent the above may not apply to you.

Export Control

You agree not to export from anywhere any part of the Data provided to you or any direct product thereof except in compliance with, and with all licenses and approvals required under, applicable export laws, rules and regulations. Entire Agreement: These terms and conditions constitute the entire agreement between NT (and its licensors, including their licensors and suppliers) and you pertaining to the subject matter hereof, and supersedes in their entirety any and all written or oral agreements previously existing between us with respect to such subject matter.

Governing Law

The above terms and conditions shall be governed by the laws of the State of Illinois, without giving effect to (i) its conflict of laws provisions, or (ii) the United Nations Convention for Contracts for the International Sale of Goods, which is explicitly excluded. You agree to submit to the jurisdiction of the State of Illinois for any and all disputes, claims, and actions arising from or in connection with the Data provided to you hereunder.

Government End Users

If the Data is being acquired by or on behalf of the United States government or any other entity seeking or applying rights similar to those customarily claimed by the United States government, this Data is a "commercial item" as that term is defined at 48 C.F.R. ("FAR") 2.101, is licensed in accordance with this End User License Agreement, and each copy of Data

delivered or otherwise furnished shall be marked and embedded as appropriate with the following "Notice of Use," and be treated in accordance with such Notice:



NOTICE OF USE

CONTRACTOR (MANUFACTURER/
SUPPLIER)

NAME:

NAVTEQ

CONTRACTOR (MANUFACTURER/
SUPPLIER)

ADDRESS:

**425 West Randolph Street,
Chicago, IL 60606.**

This Data is a commercial item as defined in FAR 2.101 and is subject to the End User License Agreement under which this Data was provided.

© 2012 NAVTEQ. All rights reserved.

If the Contracting Officer, federal government agency, or any federal official refuses to use the legend provided herein, the Contracting Officer, federal government agency, or any federal official must notify NAVTEQ prior to seeking additional or alternative rights in the Data.

END USER NOTICE

The marks of companies displayed by this product to indicate business locations are the marks of their respective owners. The use of such marks in this product does not imply any sponsorship, approval, or endorsement by such companies of this product.

A

Accepting or Declining a Call 84
 Adding or Removing XM
 Categories 19
 AM 25
 AM-FM Radio 14
 Audio
 Bluetooth 46
 Audio Players 37
 CD 37
 Audio System 80
 Backglass Antenna 25
 Radio Reception 24
 Autostore 8
 Auxiliary
 Devices 45

B

Bluetooth 79, 89
 Bluetooth Audio 46
 Bluetooth Controls 80

C

Call Waiting Using Steering
 Wheel Controls 84
 Call Waiting Using the
 Infotainment Controls 84
 Canceling Voice Recognition 73
 CD Player 37
 Cellular Phone Usage 25
 Cleaning High Gloss Surfaces
 and Vehicle Information and
 Radio Displays 14
 Clearing the System 87
 Conference Calling Using the
 Infotainment Controls 85
 Configure Menu 64
 Controls
 Steering Wheel 8
 Customer Assistance 4

D

Database Coverage
 Explanations 72
 Destination Download,
 OnStar® 63
 Destination, Navigation 54
 Detailed Areas 51
 Devices
 Auxiliary 45
 USB 39
 Display Settings 69
 Driving on a Route 53
 Dual Tone Multi-Frequency
 (DTMF) Tones 86

E

Ending a Call 85
 Error Messages 38

F

Finding a Station 15
 FM 25

G

Global Positioning System (GPS)	70
Gracenote	89
Gracenote®	39

H

Hands-Free Phone	86
Helpful Hints for Speaking Commands	73
Home Page	9
Home Page Customization	9
Home Page Features	10

I

Info	
Quick	26
Infotainment	3
Infotainment Control Buttons	7
Infotainment System Overview ...	4
Infotainment System Settings ...	15
Internet Radio	
Pandora	26

L

Languages	65
Launching Pandora	27
Launching Stitcher	32
Loading and Ejecting Discs	37

M

Making a Call	86
Making a Call Using Phone Book and Infotainment Controls	83
Making a Call Using the Infotainment Controls	84
Map Adjustments	50
Map Data Updates	72
Map End User License Agreement (Optional Equipment Applies Where Equipped)	89
Map Scales	50
Maps	51
Menu	
Configure	64

Menu with Route Guidance

Active	61
Mixed-Band Presets	16
Muting a Call	85
My Media Commands	75

N

Navigation	
Destination	54
Symbols	51
Using the System	47
Navigation Commands (If Equipped)	77
Navigation Settings	66
Navigation Settings Button	66
NavTraffic® (If Equipped)	20

O

OnStar® Destination	
Download	63
Other Commands	76
Overview	79
Overview, Infotainment System ...	3

P

Pairing with Infotainment
 Controls 80
 Pairing with Voice Recognition ... 82
 Pandora (If Equipped) 89
 Pandora Internet Radio 26
 Pandora Troubleshooting 30
 Phone
 Bluetooth 79
 Hands-Free 86
 Phone Commands 75
 Phone Settings 66
 Pictures 36
 Playing an Audio CD 38
 Playing from a USB 39
 Playing from an iPhone
 or iPad 45
 Playing from an iPod® 43
 Playing the Radio 14
 Problems with Route
 Guidance 71

Q

Quick Info 26

R

Radio Commands 74
 Radio Settings 65
 Radios
 AM-FM Radio 14
 Reception 24
 Satellite 17
 Route Options 60

S

Satellite Radio 17
 Scroll Features 50
 Settings Commands 76
 SiriusXM Categories 19
 SiriusXM Messages 19
 SiriusXM® Satellite Radio 17
 SiriusXM® Satellite Radio
 Service 25
 Steering Wheel Controls 8
 Stitcher Troubleshooting 35

Storing Radio Station Presets ... 16
 Symbols, Navigation 51
 System
 Infotainment 3
 System Needs Service, If 72

T

Time and Date Settings 65
 Touch Screen Buttons 8
 Transferring a Call 85
 Travel Link (If Available) 21
 TuneSelect 18

U

Updates
 Map Data 72
 USB 39
 USB Media Formats 39
 USB troubleshooting 45
 Using Bluetooth Voice
 Recognition 86
 Using Destination Download 63
 Using the System 9
 Using Voice Recognition 72

V

Vehicle	
Positioning	70
Vehicle Settings	69
Viewing	
Pictures	36
Voice Recognition	72, 80
Voice Recognition Commands ...	74
Voice Recognition Help	74